



GFG
FOUNDATION

Powered by
Rewise

GFG Foundation Provocarea STEAM

Power Plant
Assembly Instructions

România



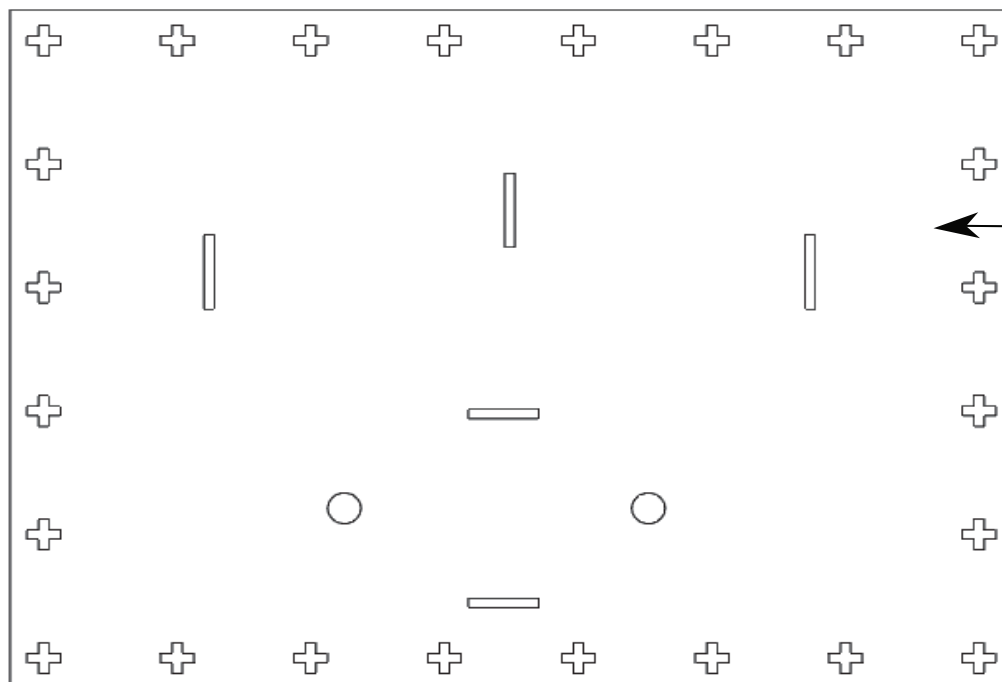
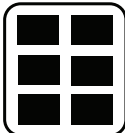

C1 x 1

C5 x 2

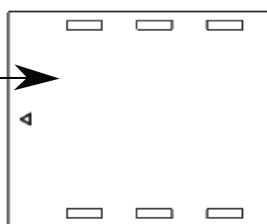

C3 x 1

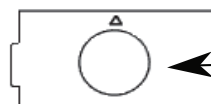

A x 5



C2 x 2

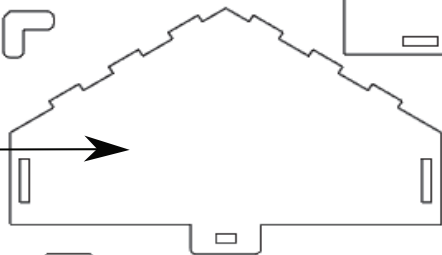

C4 x 1

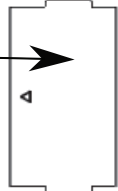

C6 x 3

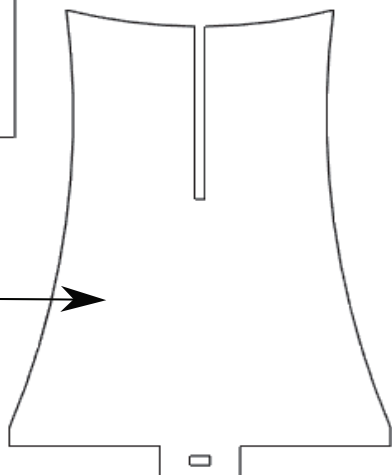

C7 x 3

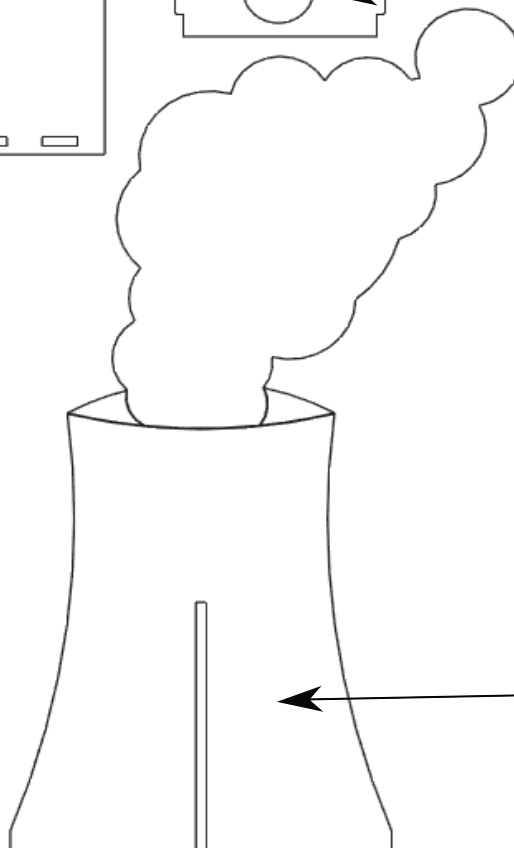

1

C3 x 1
Switch

C3

Switch

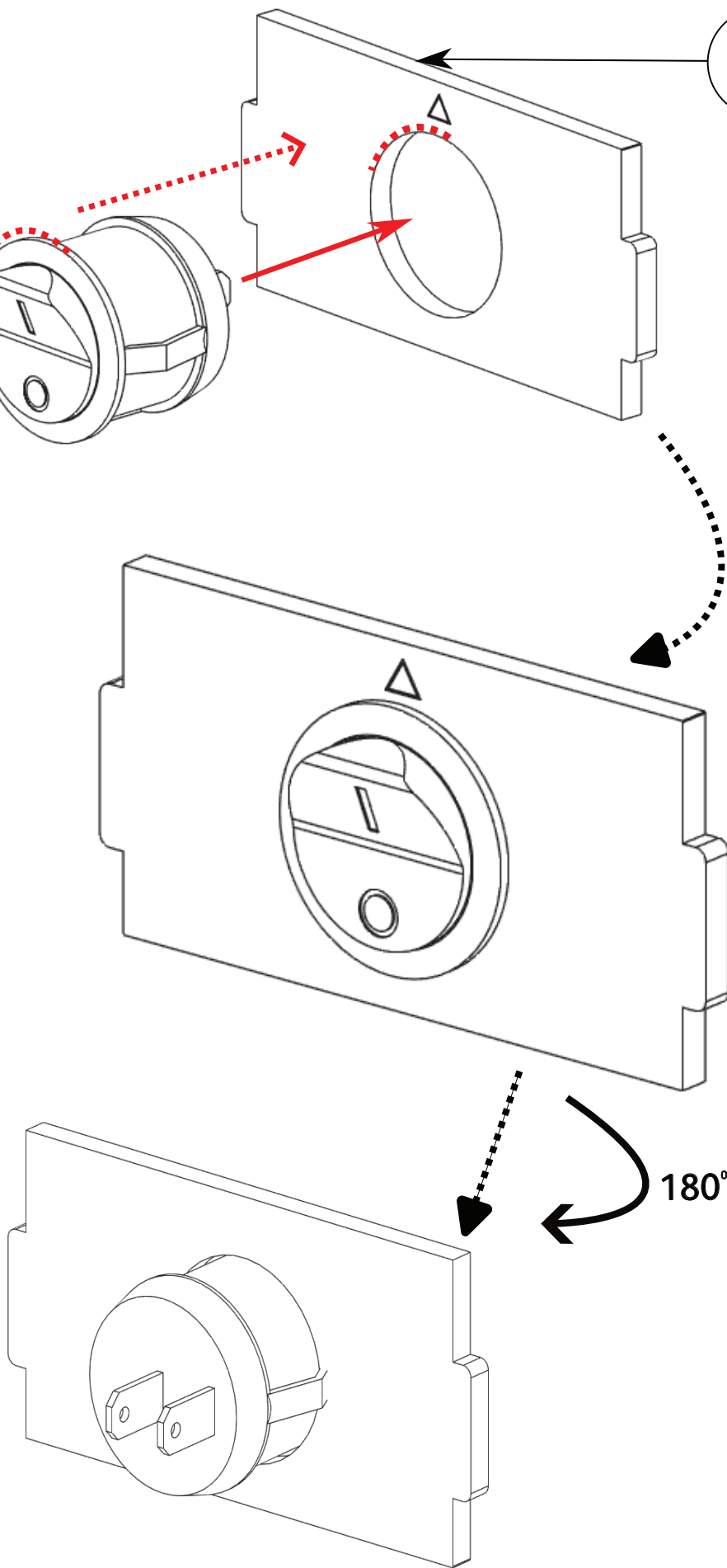

2

C3 x 1
Switch
C4 x 1
C2 x 2

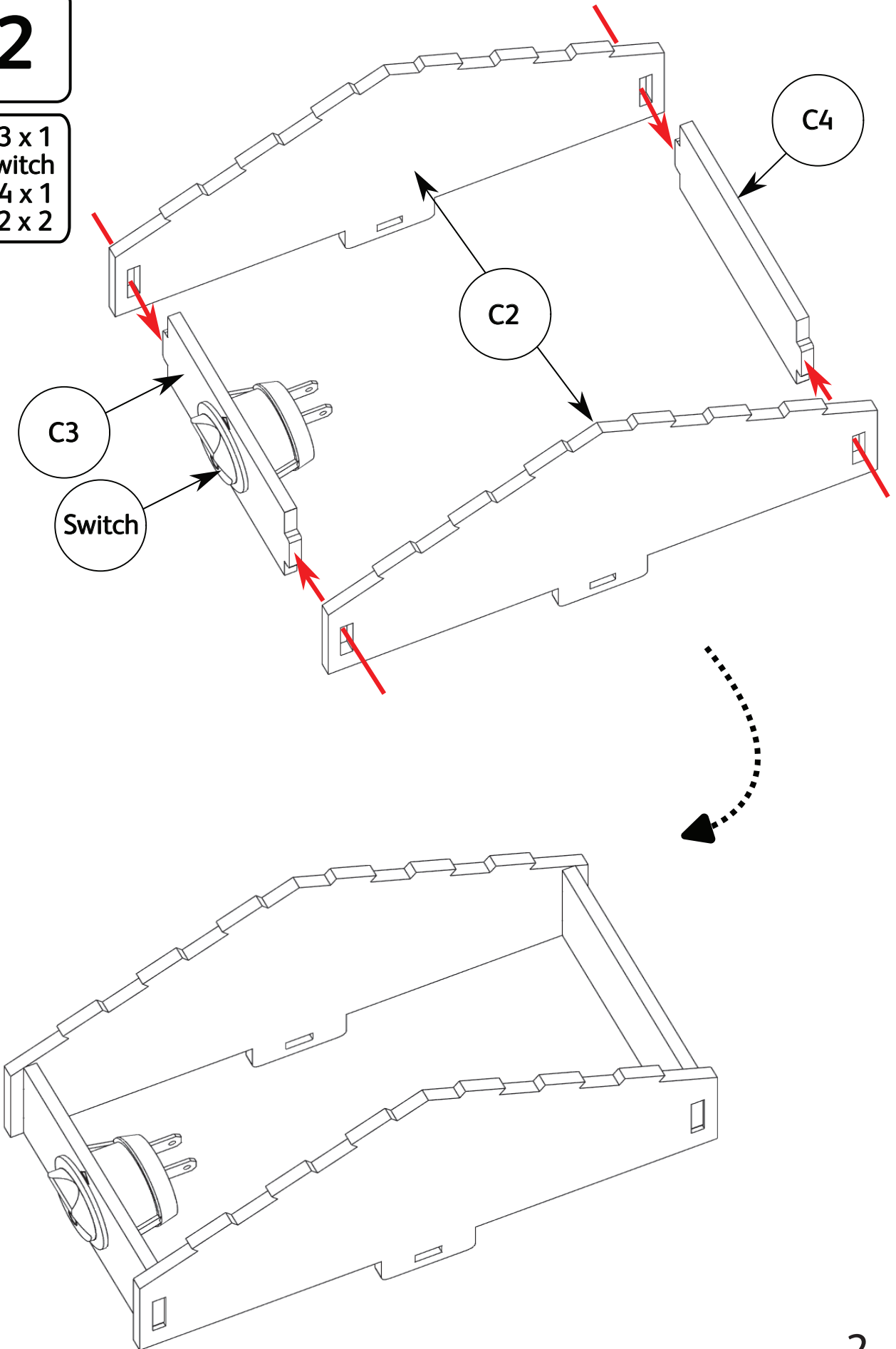

3

- C3 x 1
- Switch
- C4 x 1
- C2 x 2
- C1 x 1

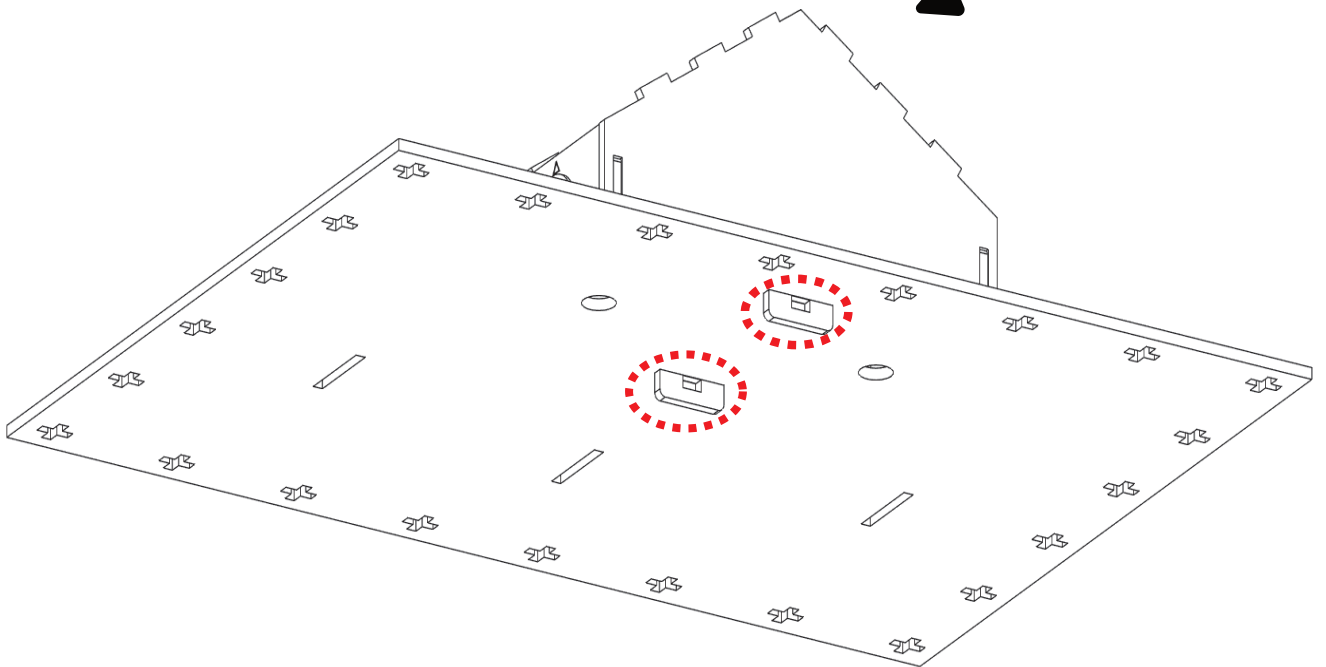
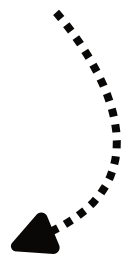
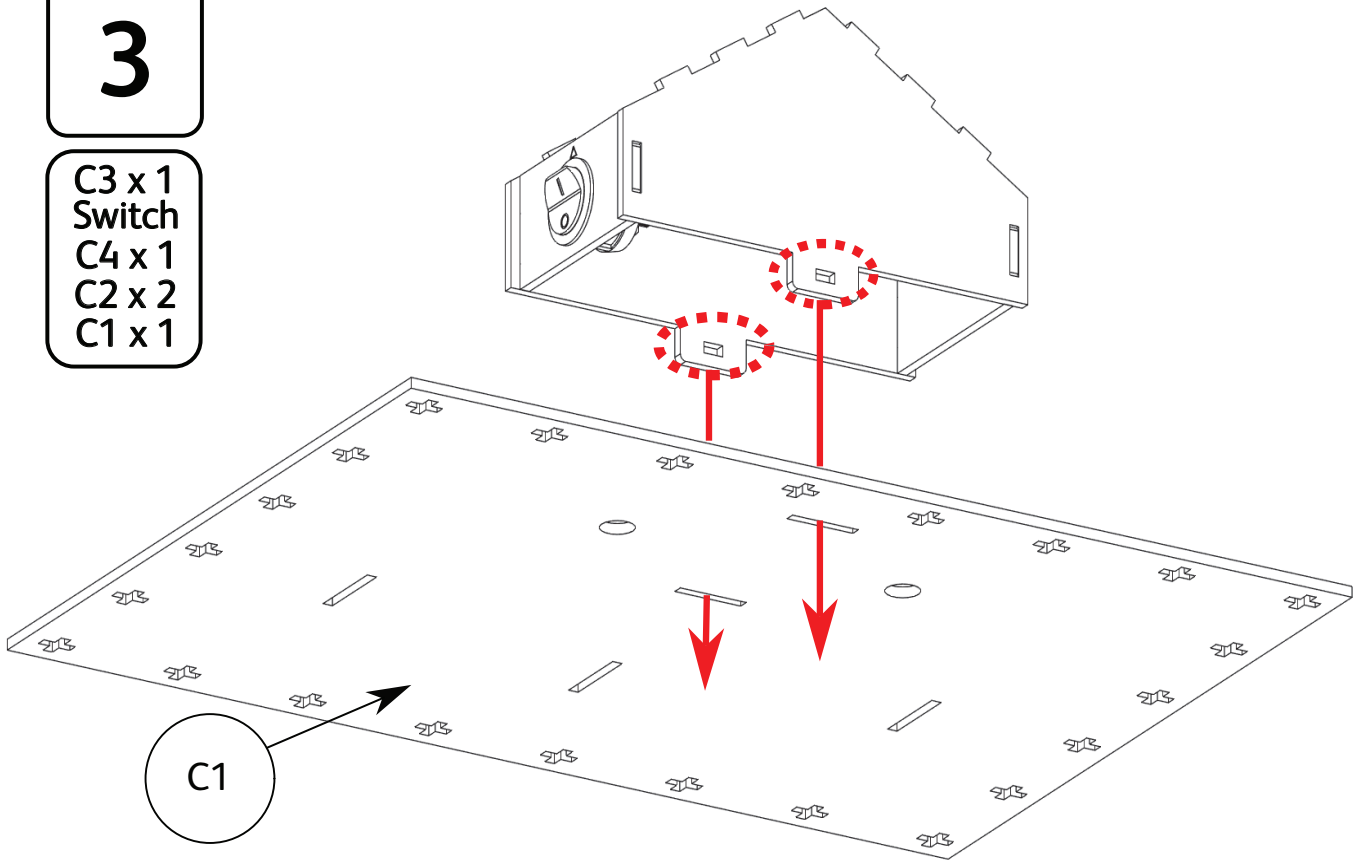

4

Ax2

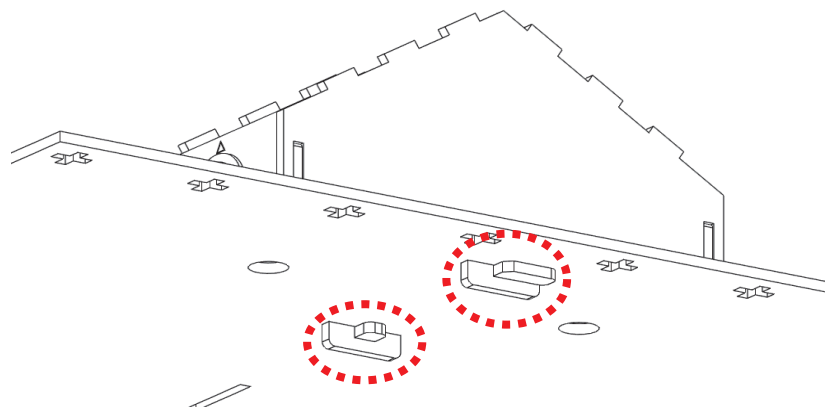
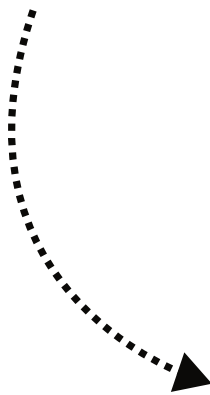
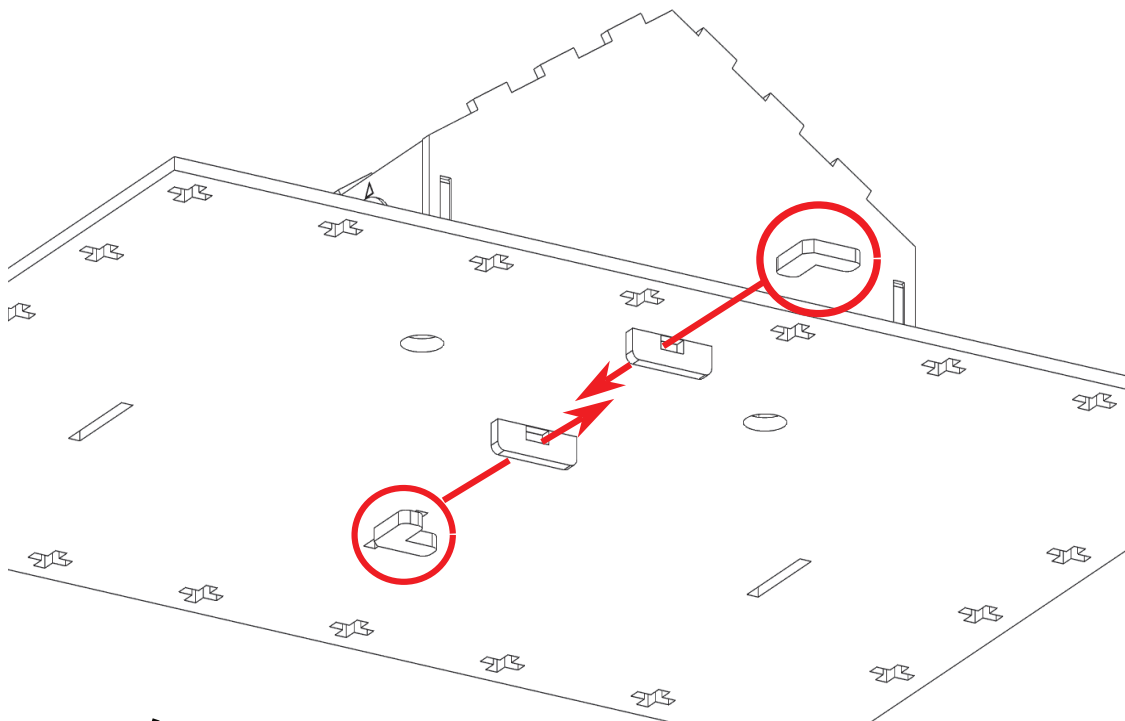
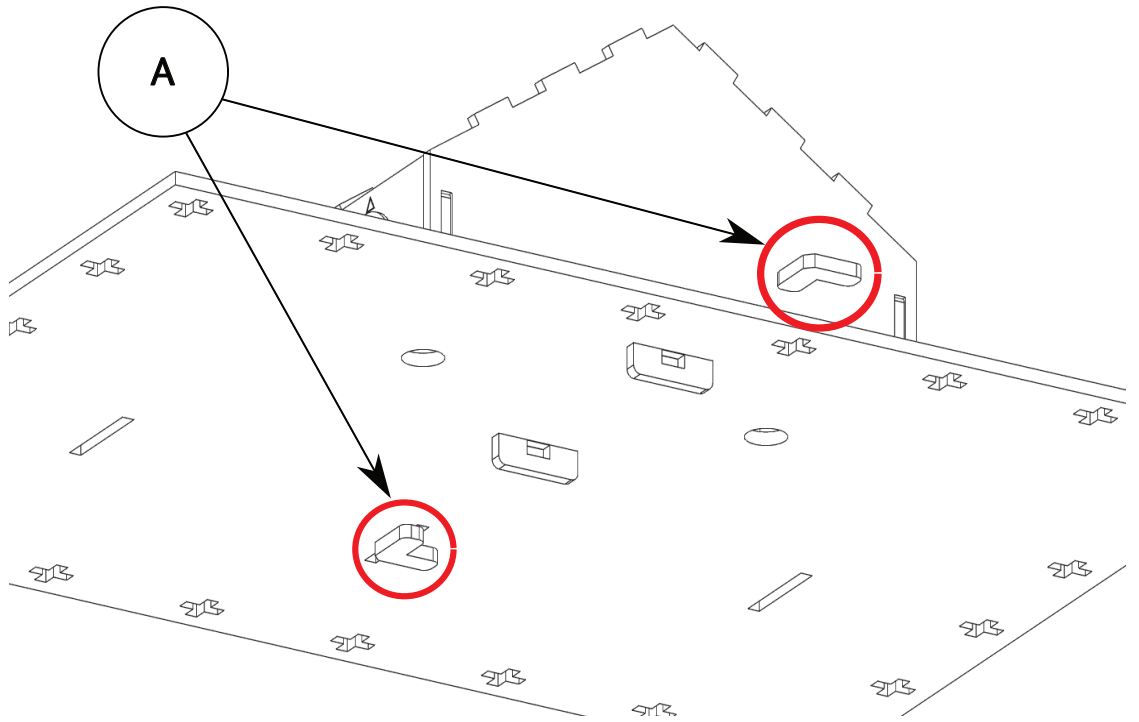

4

5

A x 2

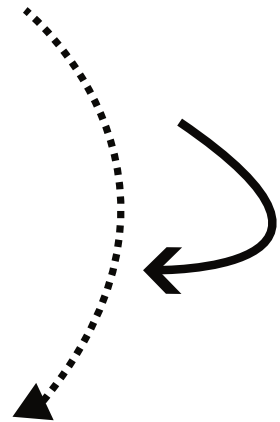
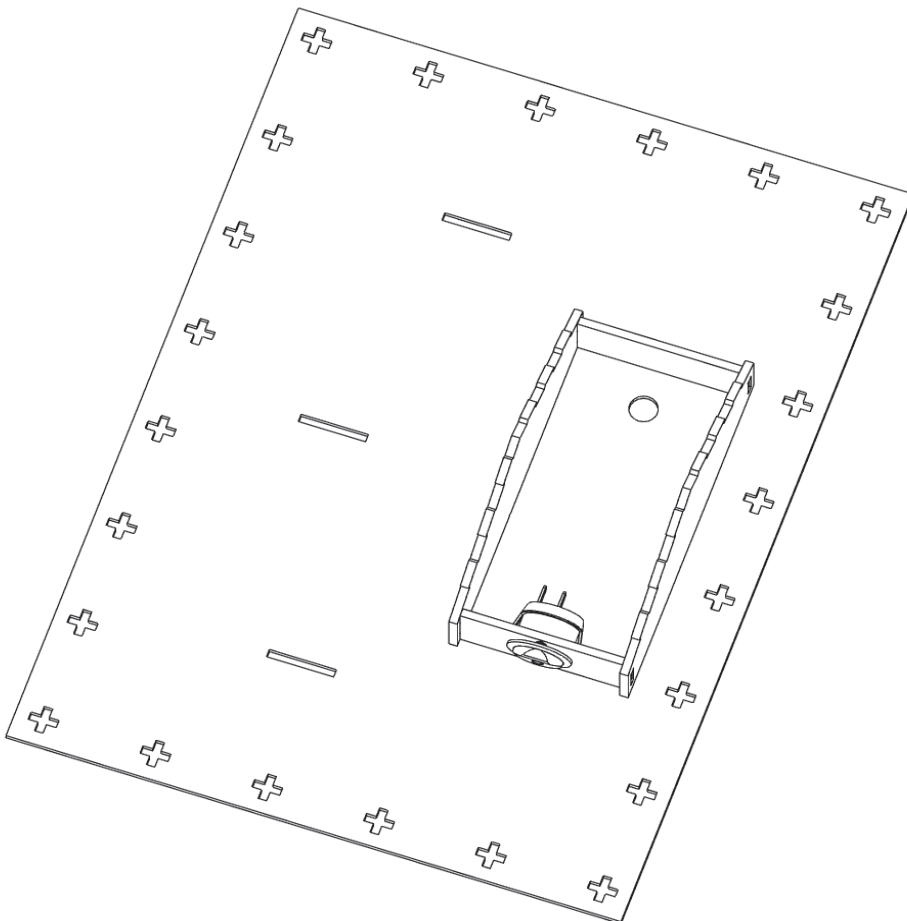
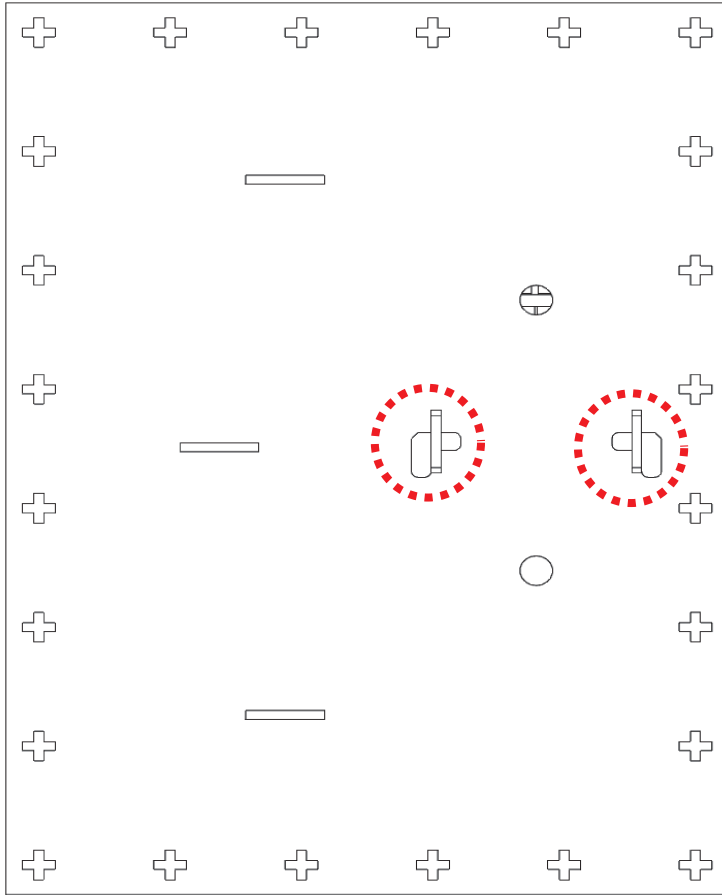

6

Battery

Battery

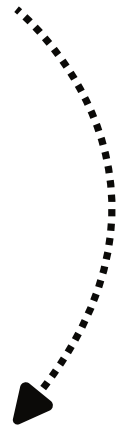
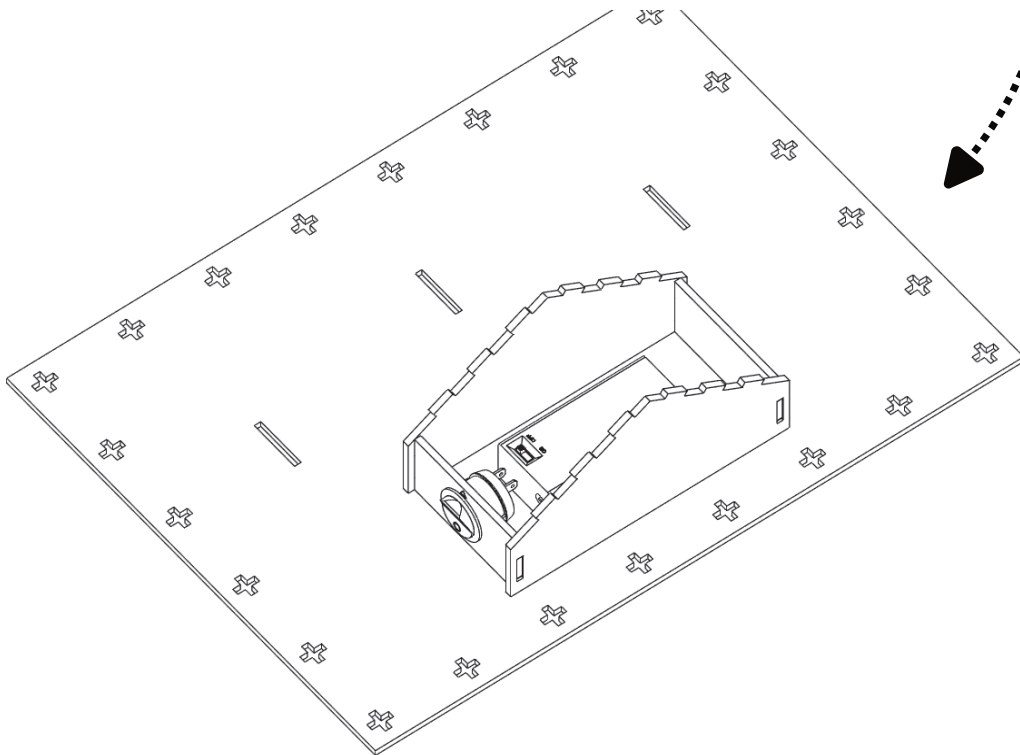
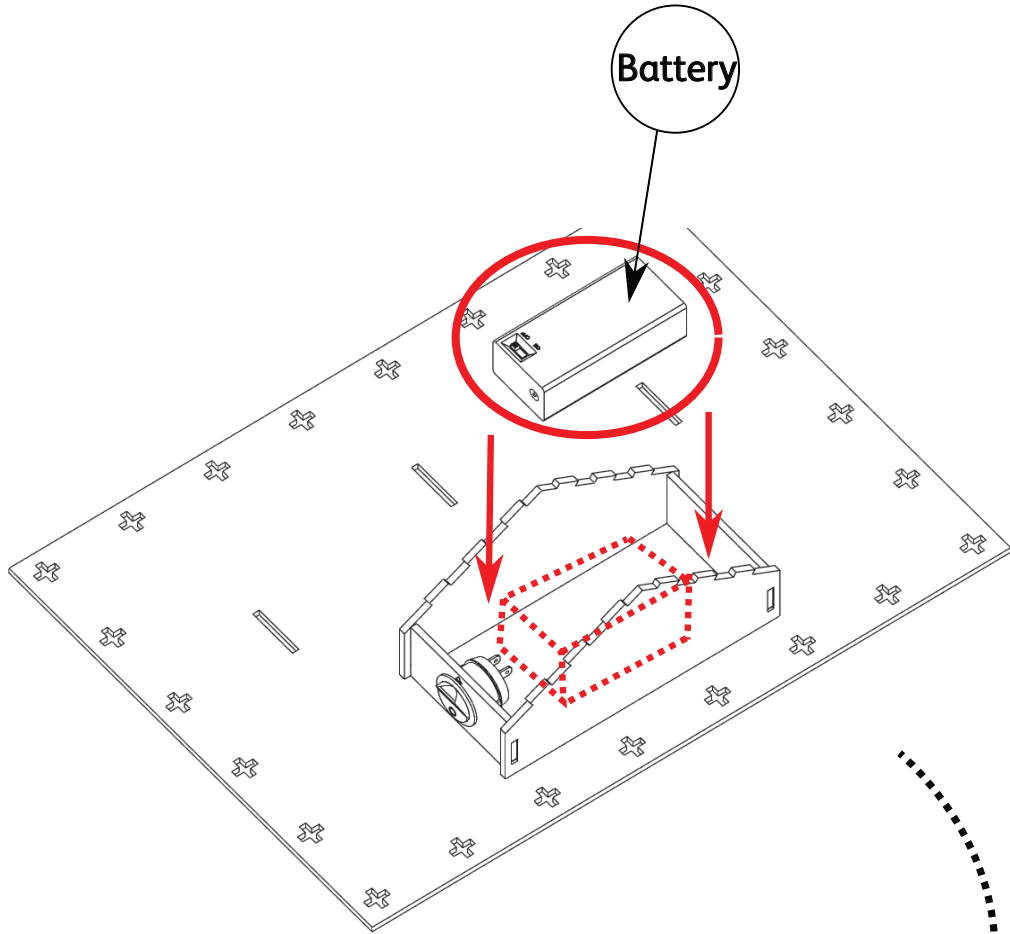

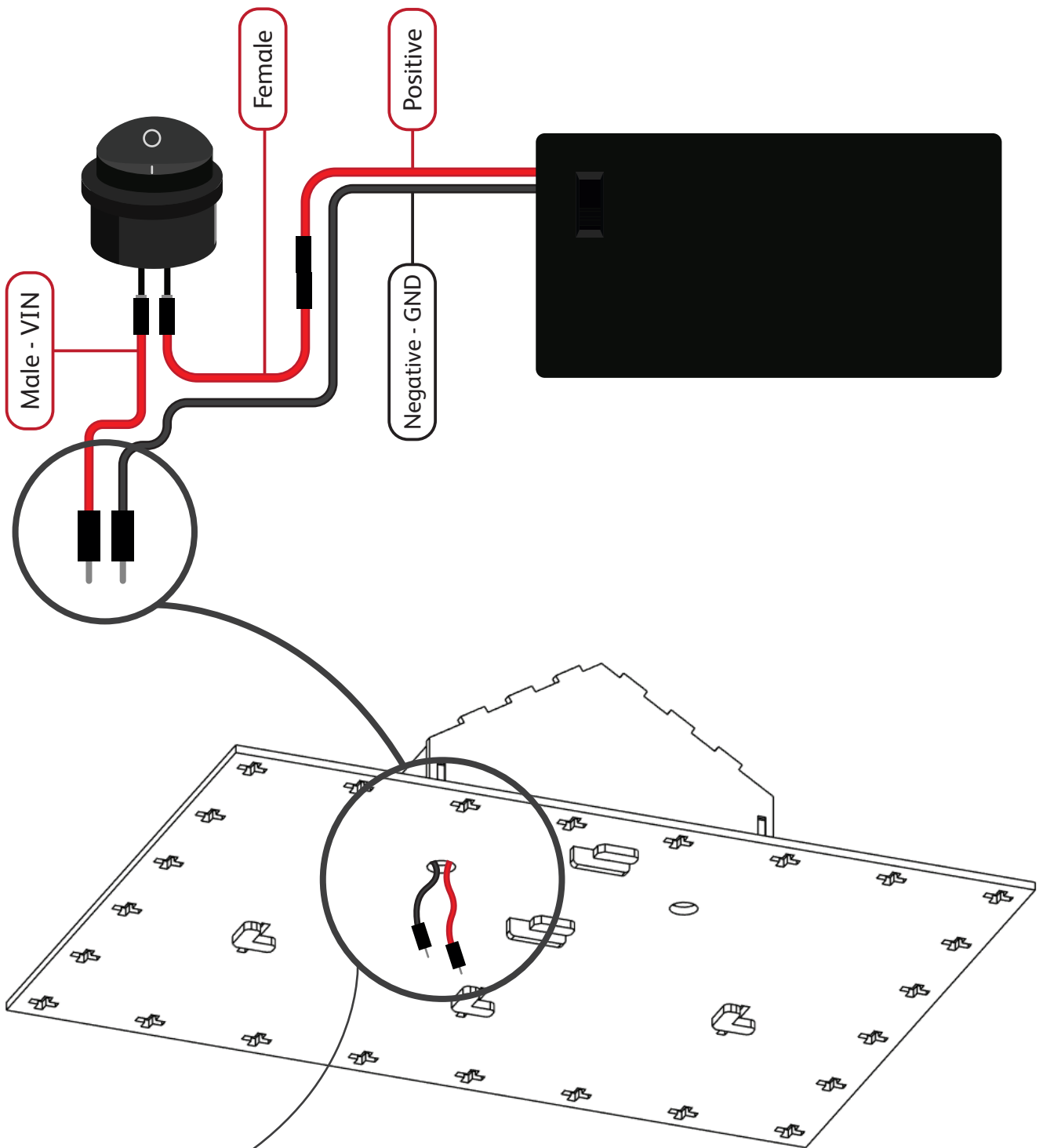
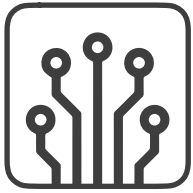

Connect to Blast
Furnace Arduino
Nano.

7

C5 x 2

C5

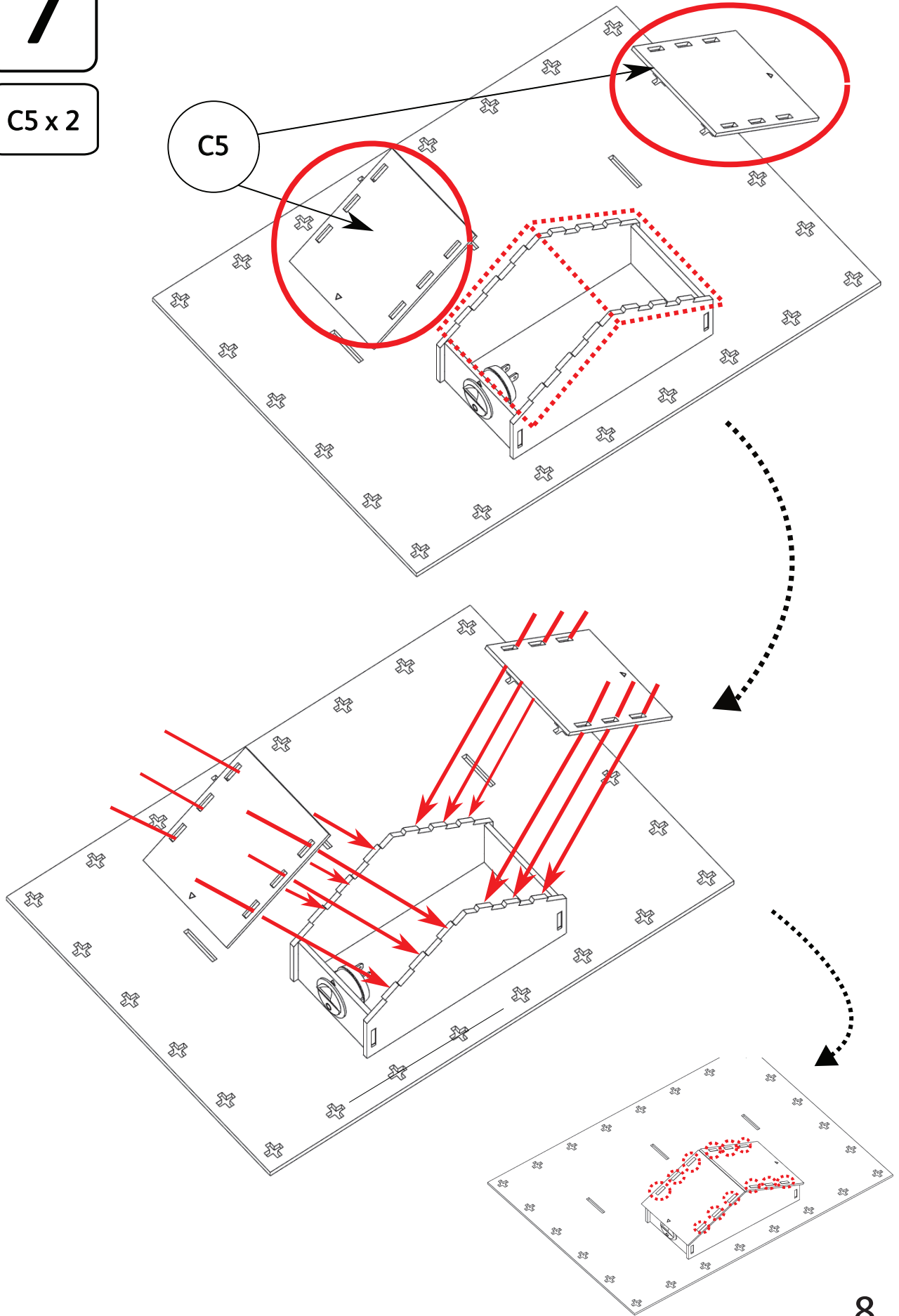

8

8

C6 x 3

C6

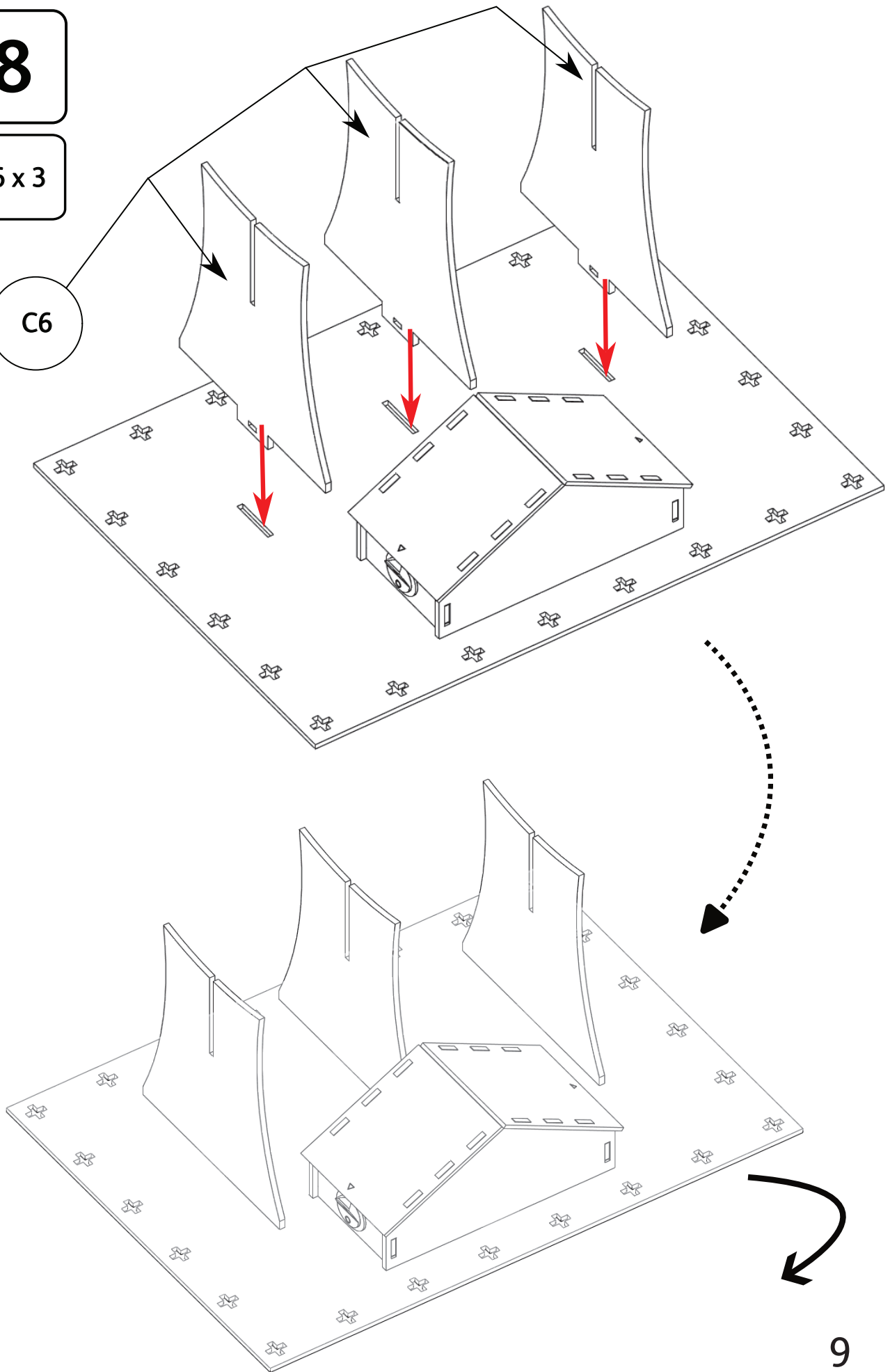

9

9

A x 3

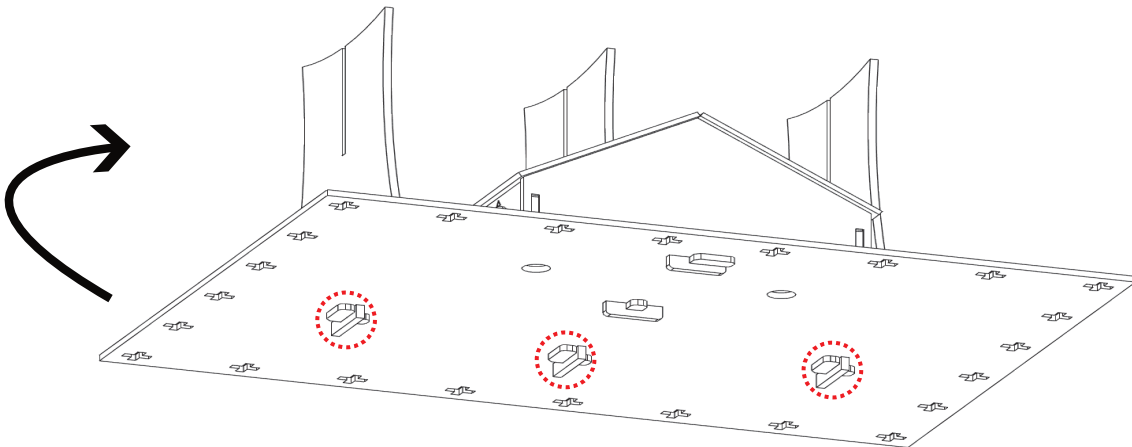
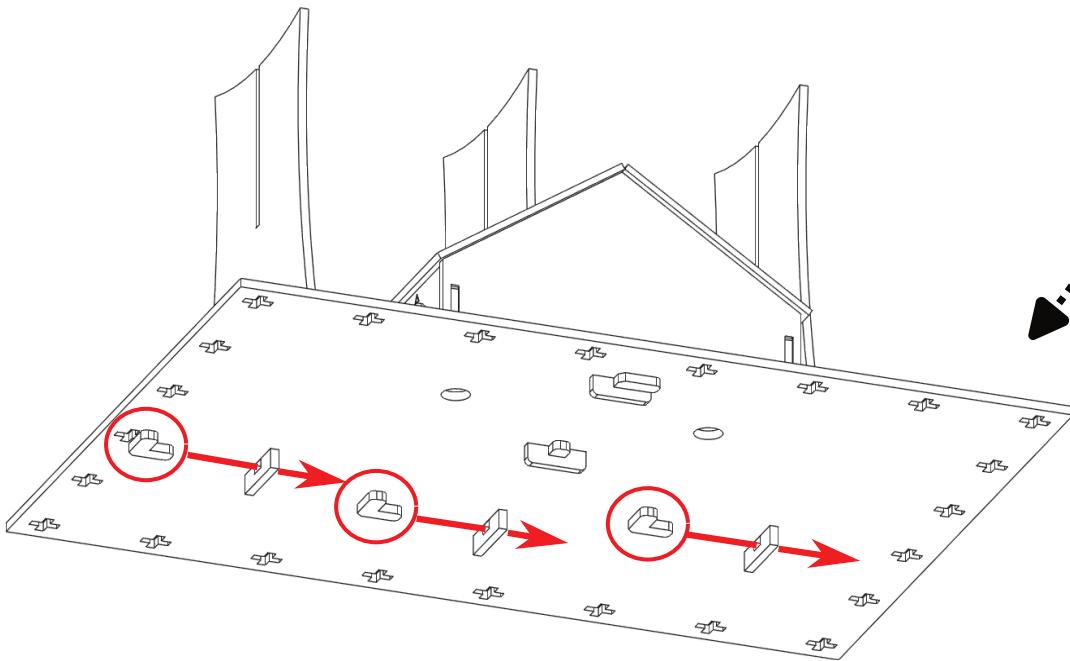
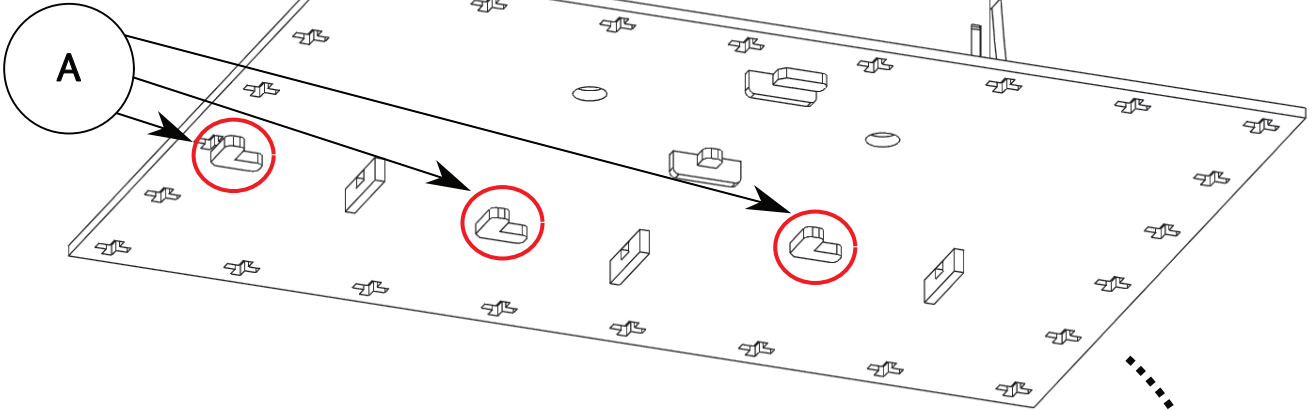

10

10

C7 x 3

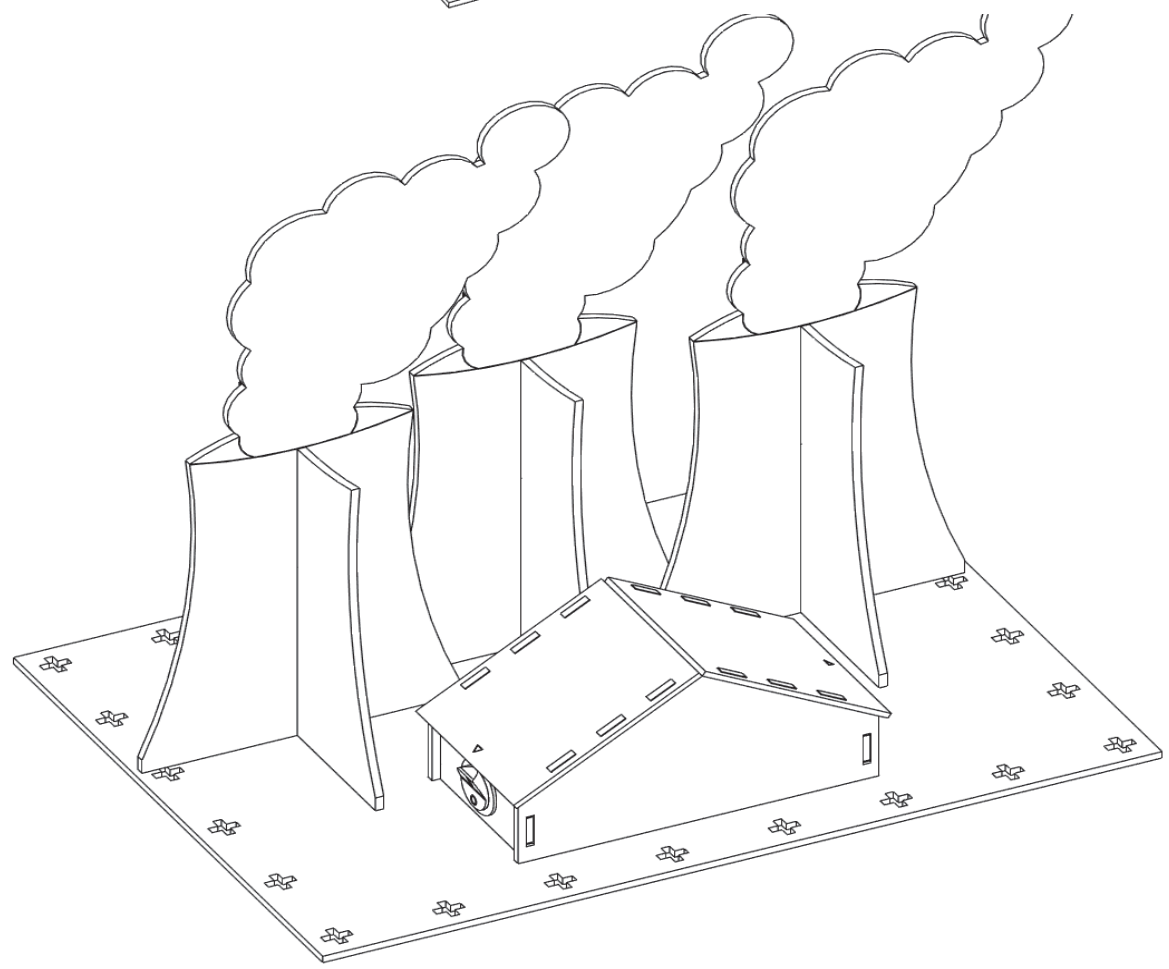
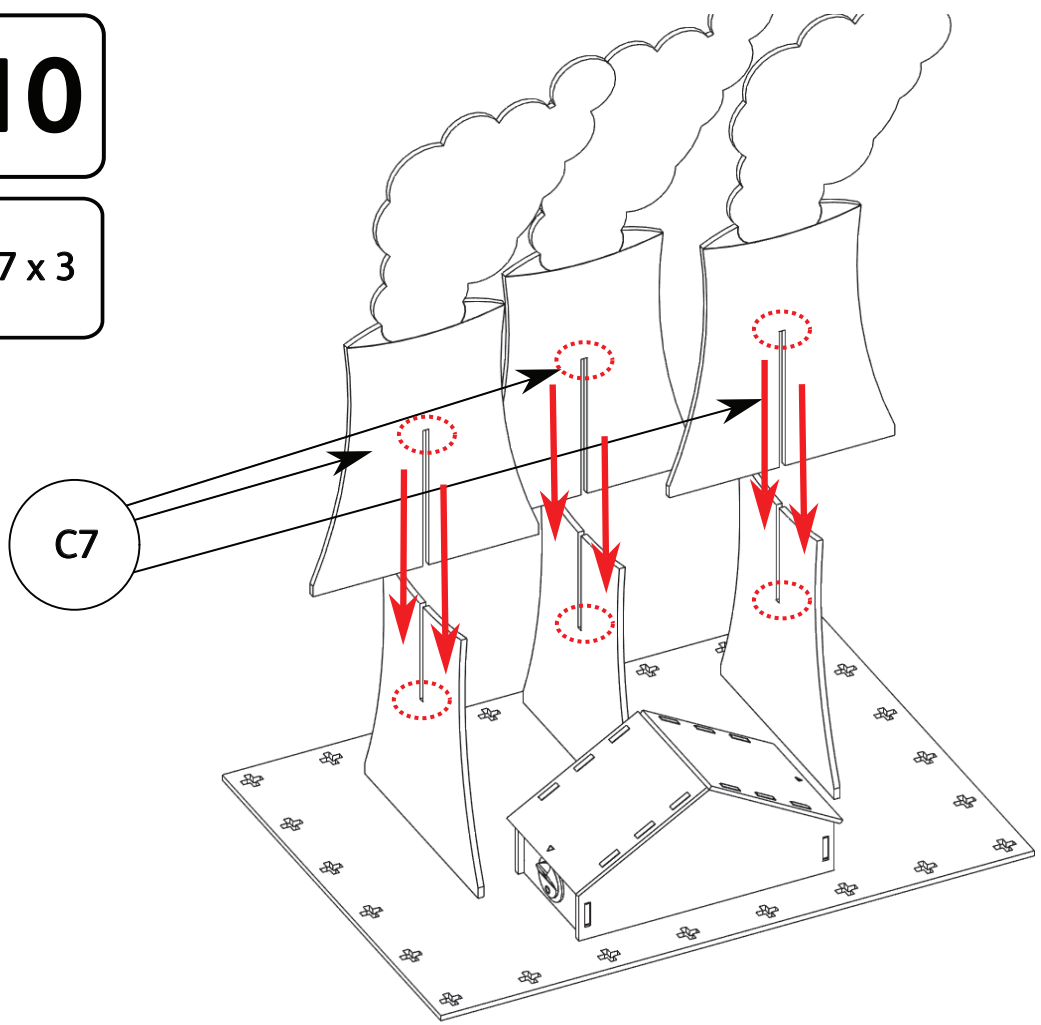



Powered by
Rewise

Romania