



GFG
FOUNDATION

Powered by
Rewise

Fundația GFG

Provocarea STEAM

Uzina de Distribuire a energiei -
Instrucțiuni de asamblare

România, 2024



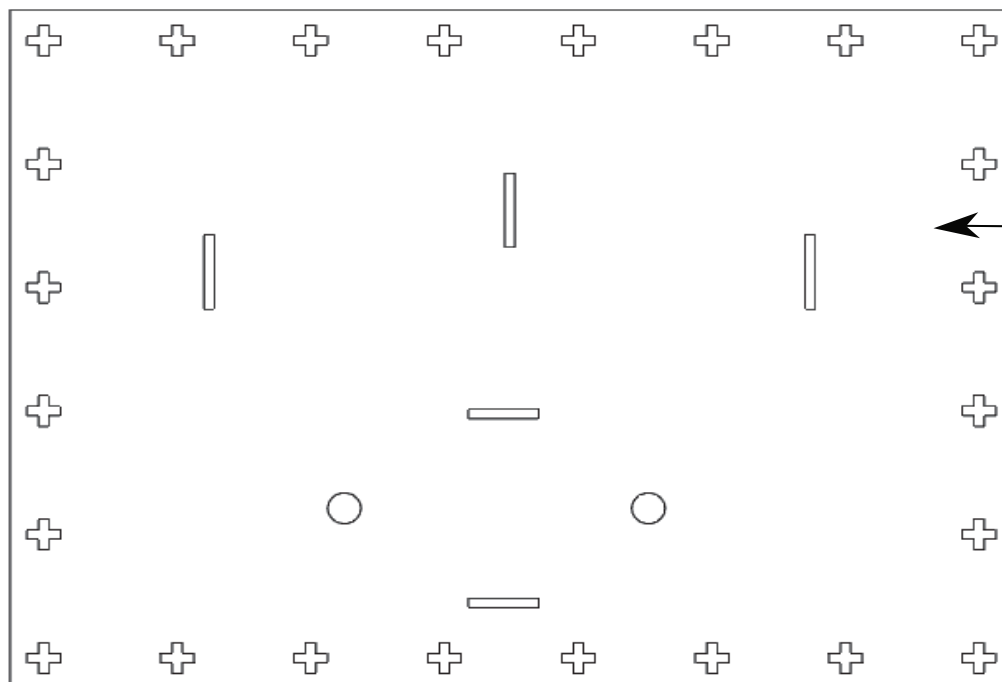
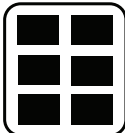

C1 x 1

C5 x 2

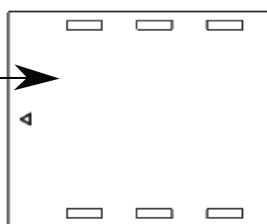

C3 x 1

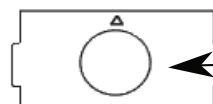

A x 5



C2 x 2

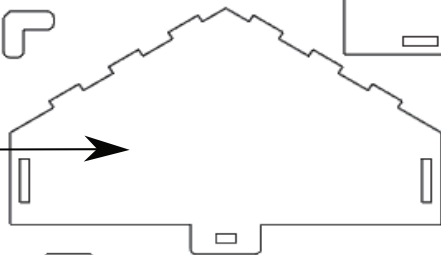

C4 x 1

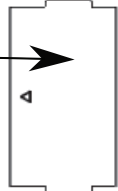

C6 x 3

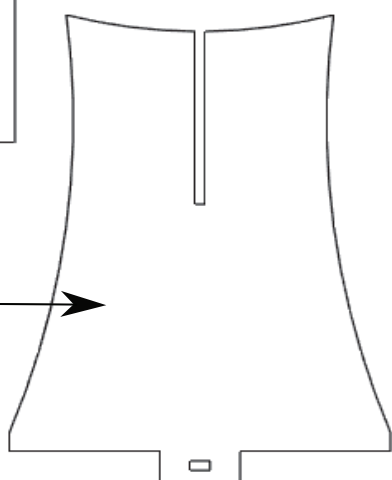

C7 x 3

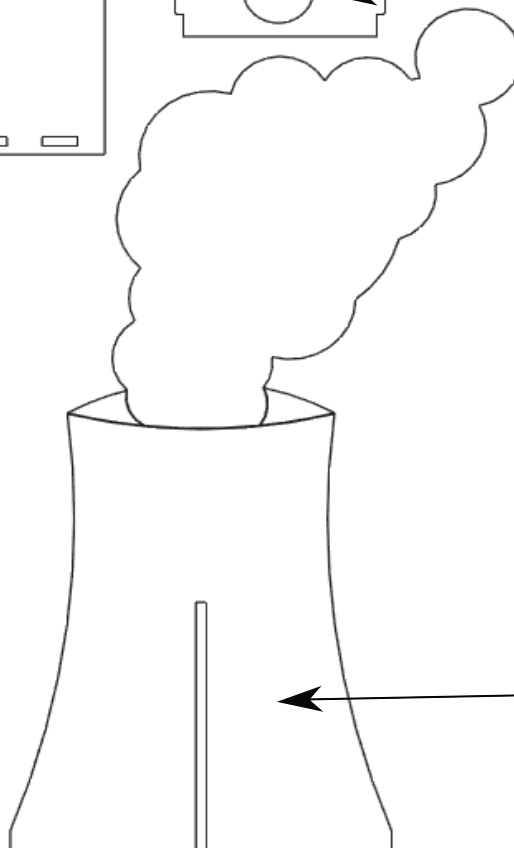

1

C3 x 1
Întreprător
x 1

Întreprător

C3

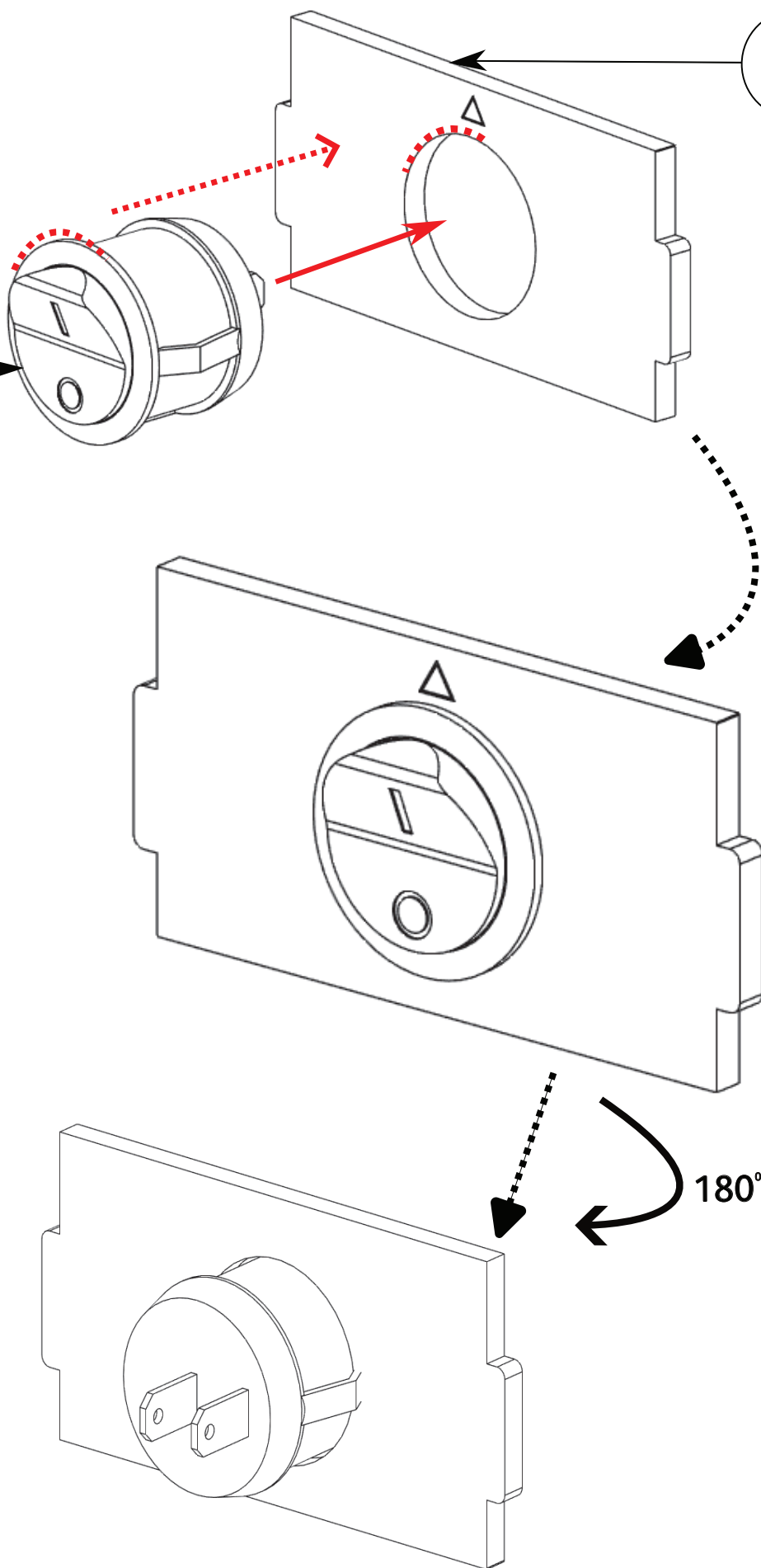

2

C3 x 1
C4 x 1
C2 x 2

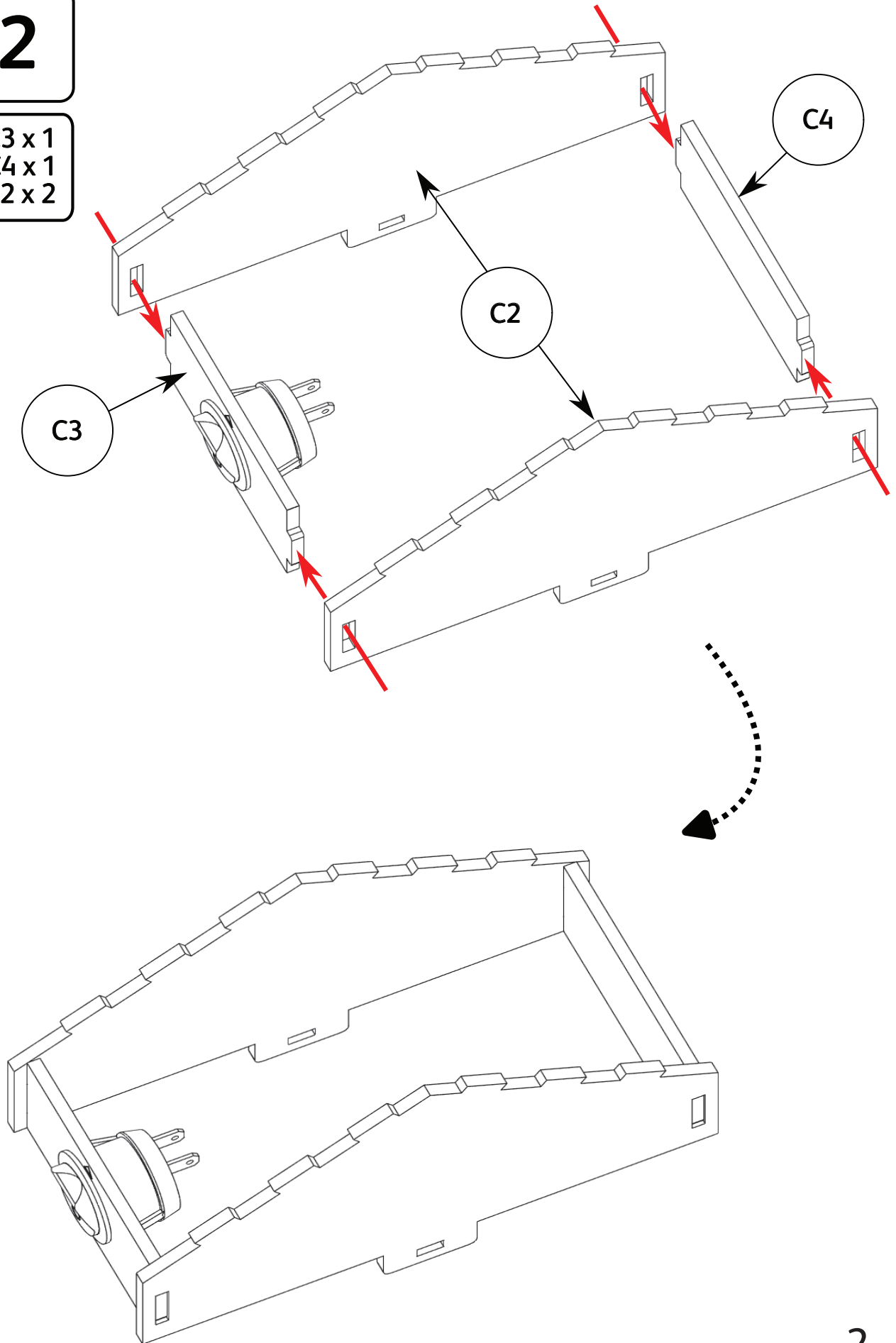

3

C1 x 1

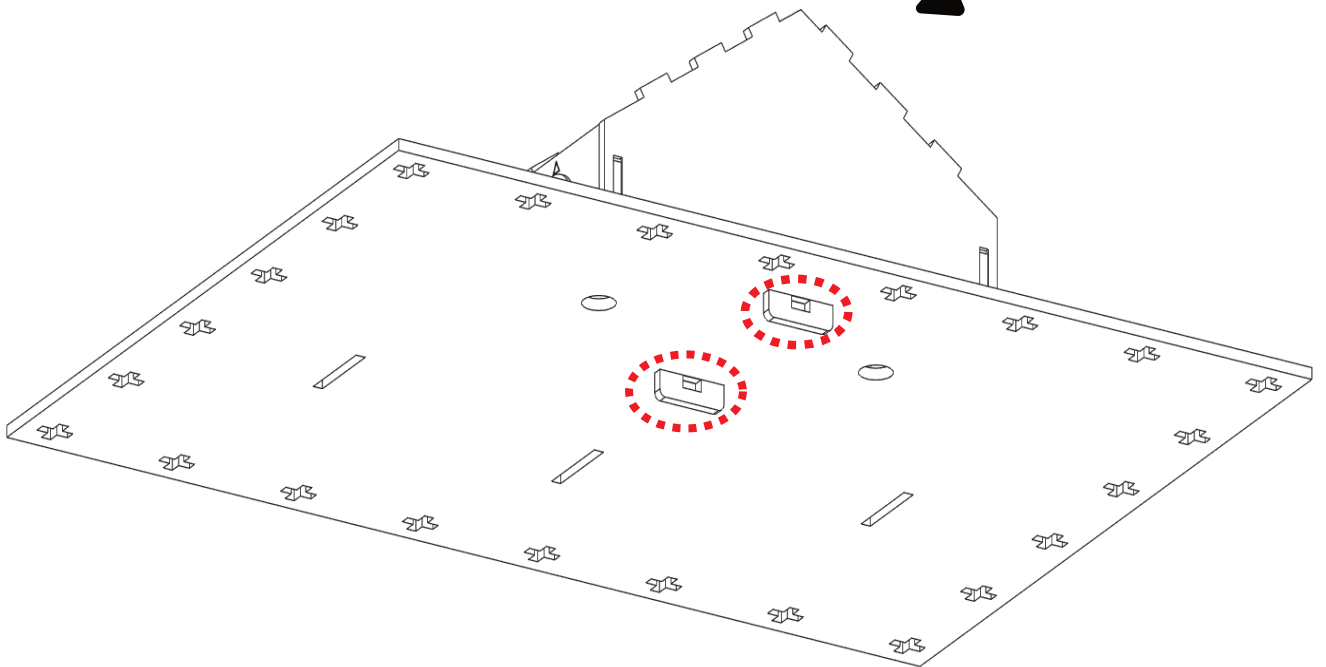
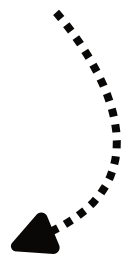
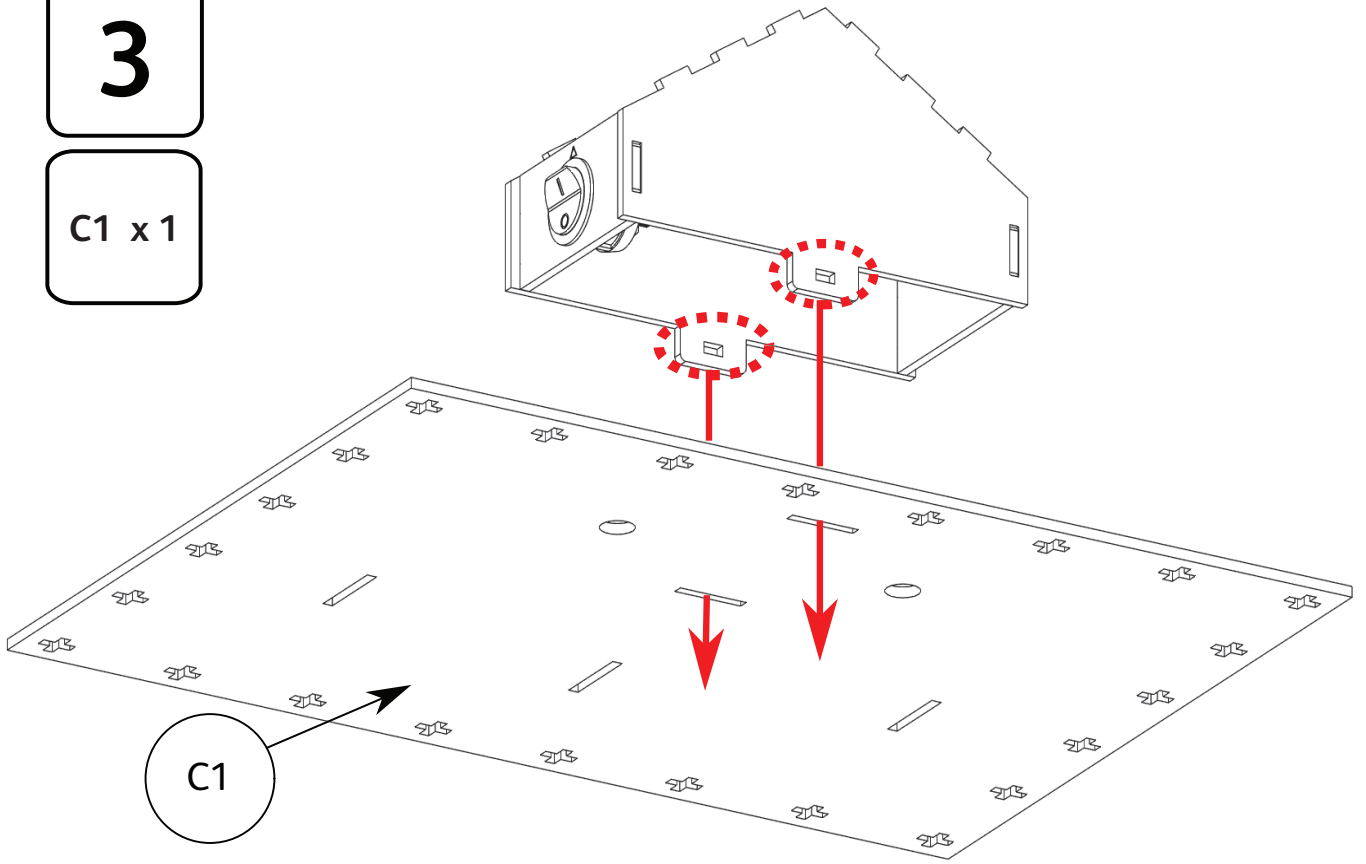

4

Ax2

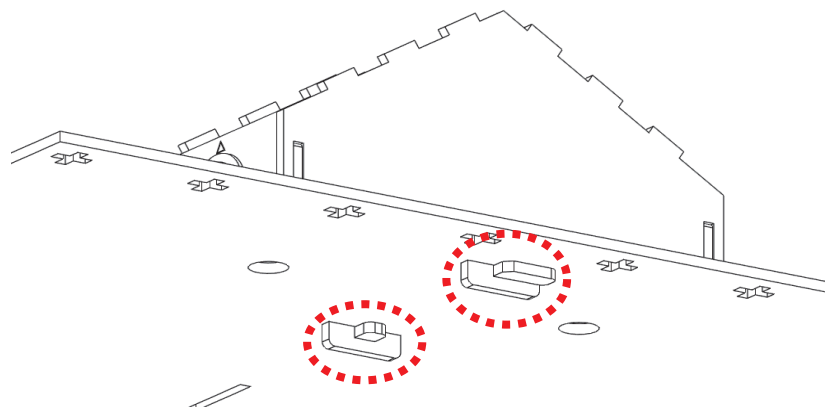
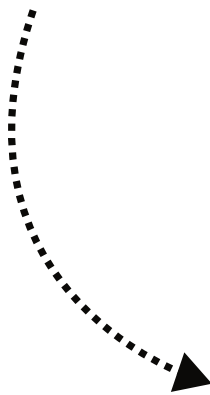
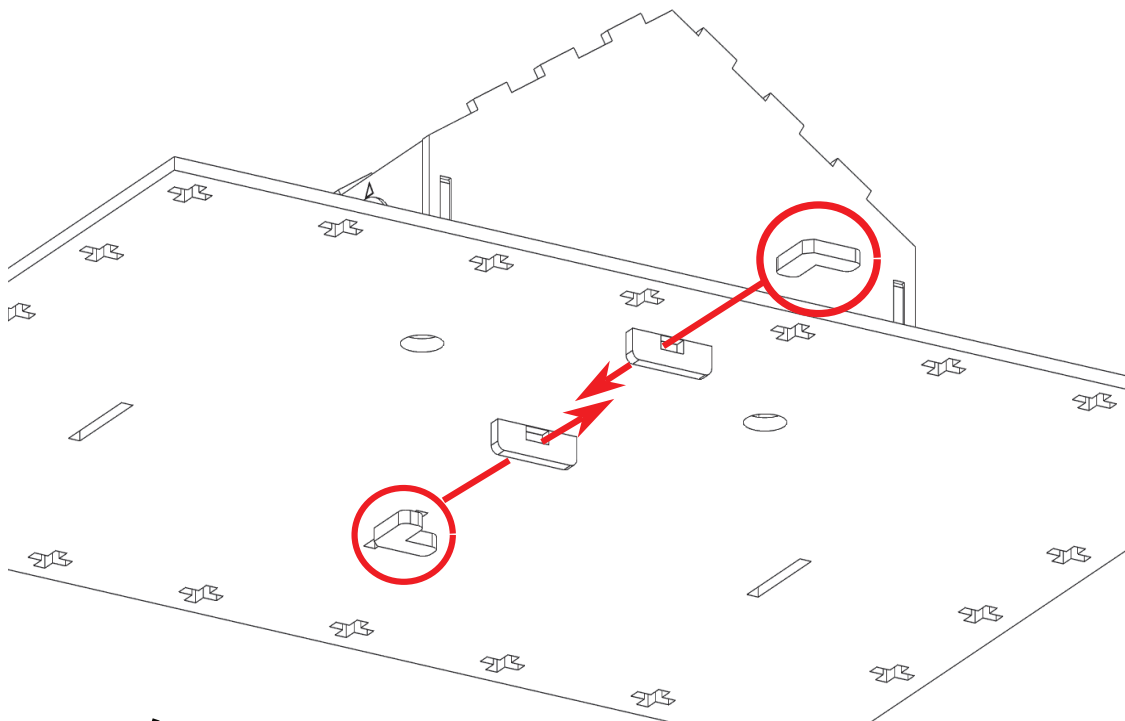
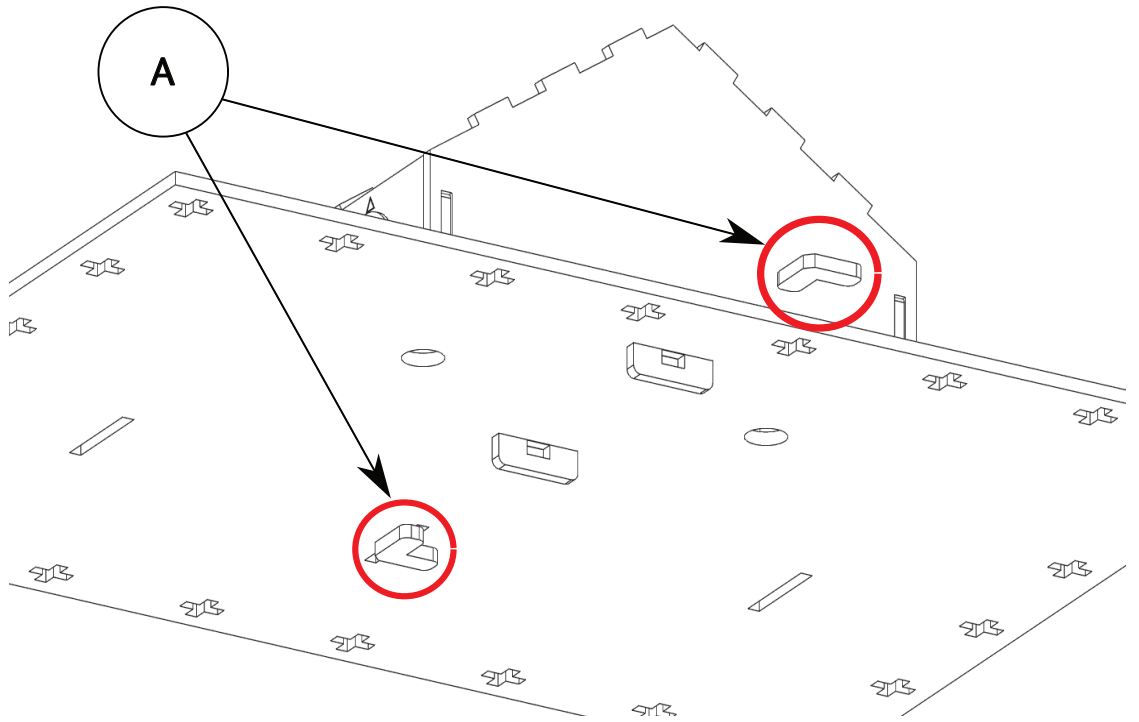

4

5

A x 2

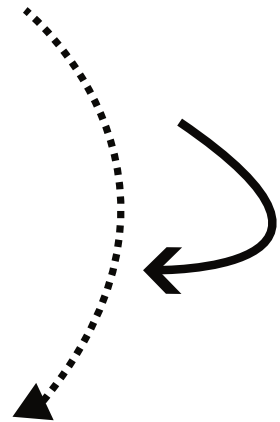
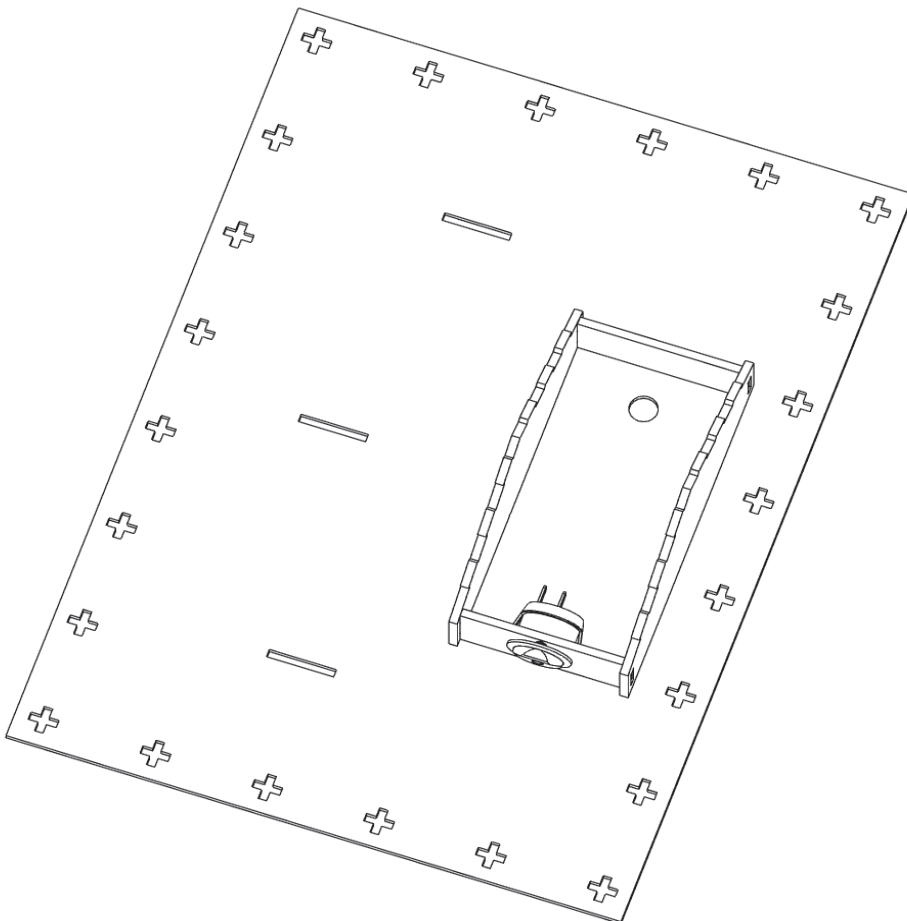
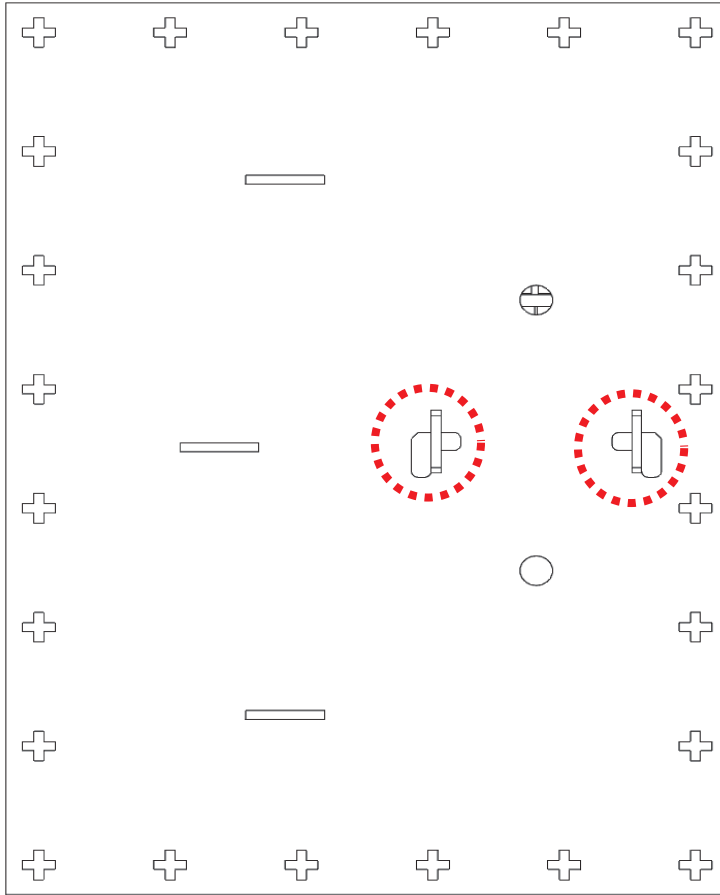

6

Baterie
x 1

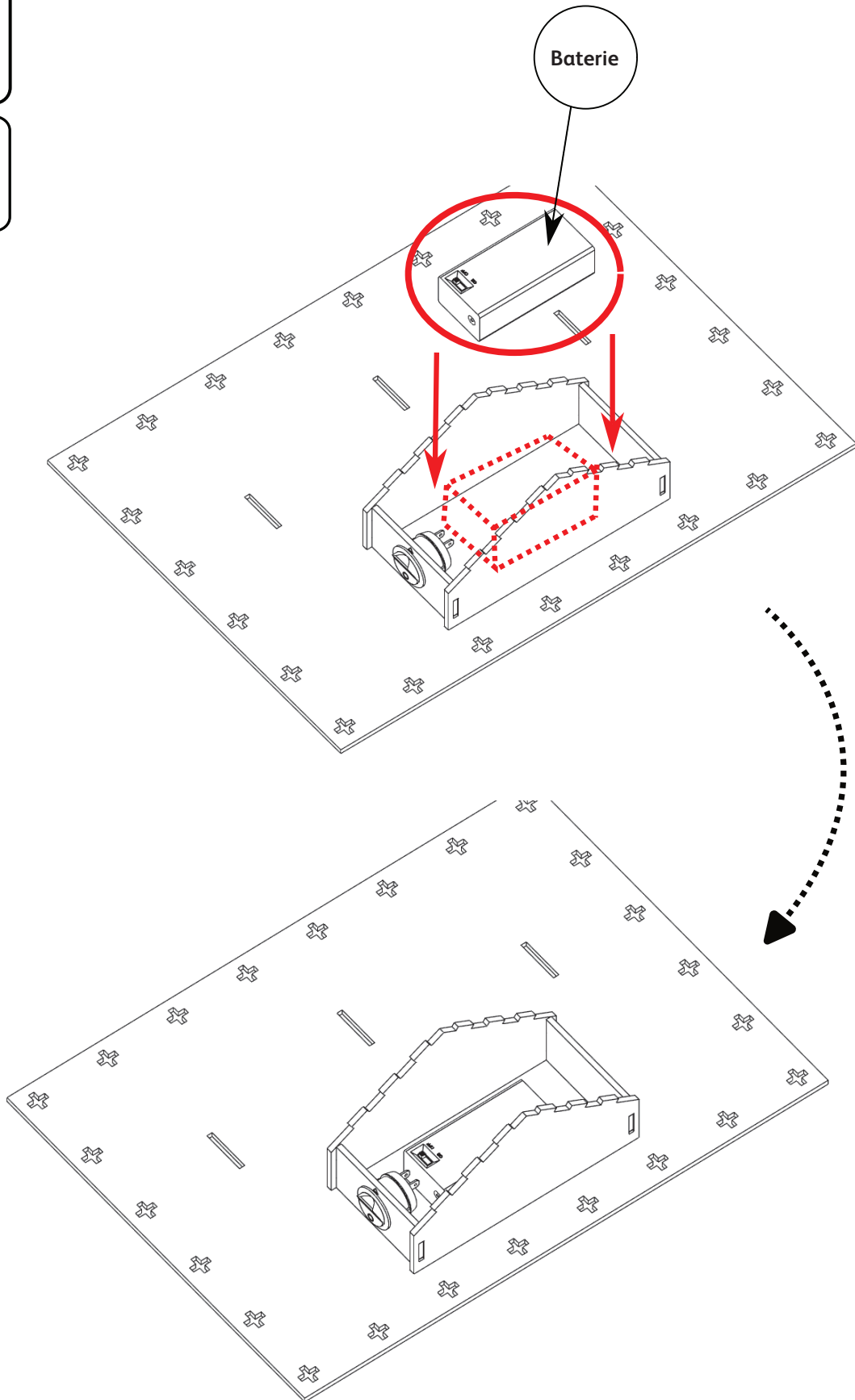

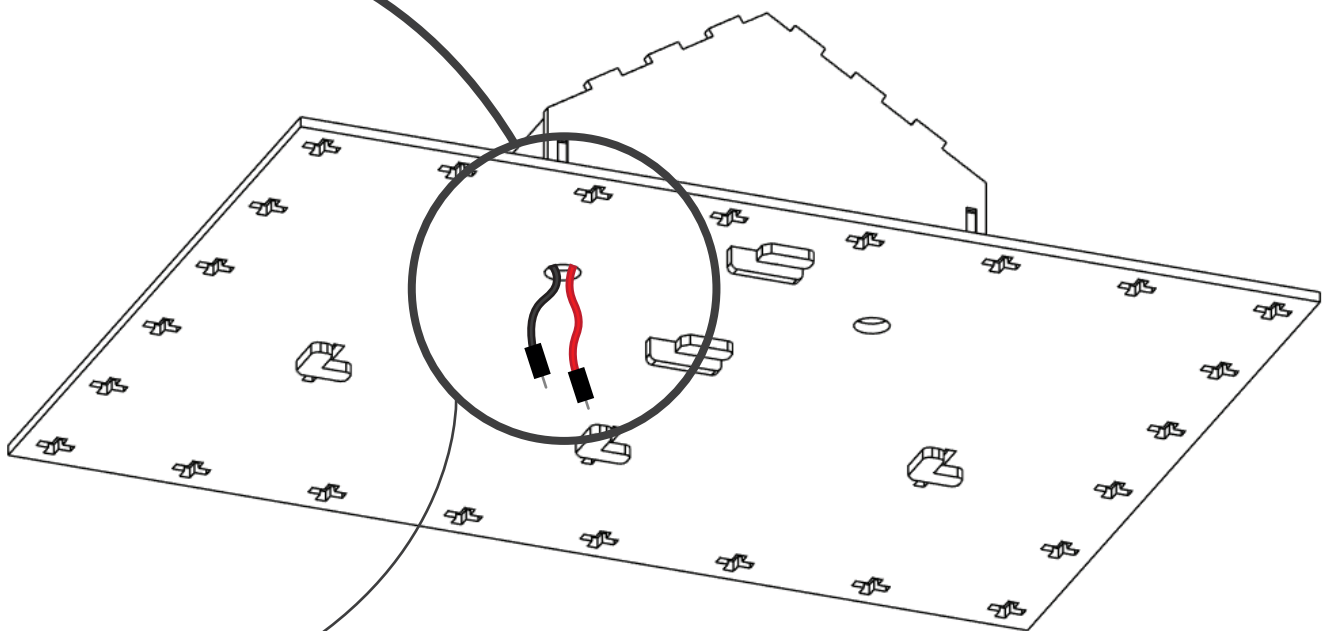
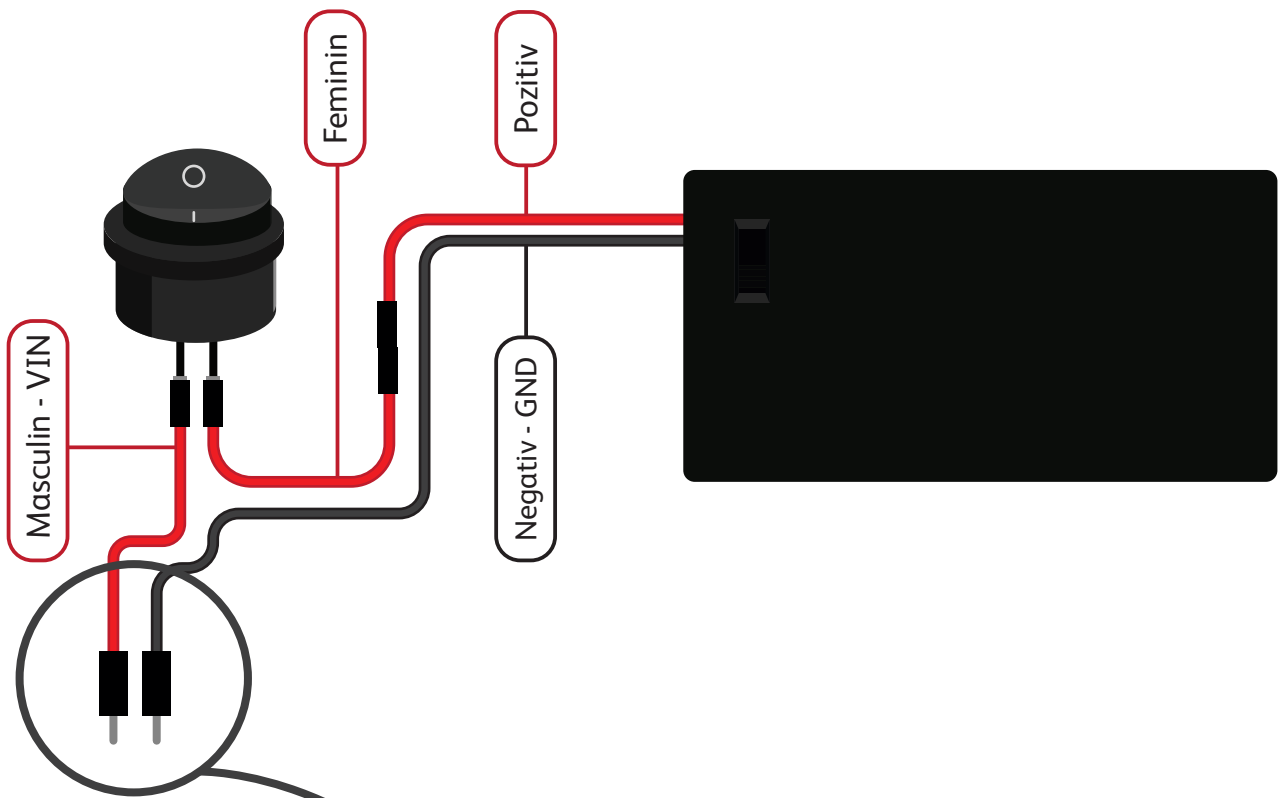
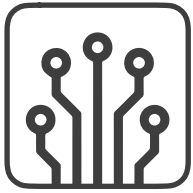

Conectare la Furnal
Arduino Nano.

7

C5 x 2

C5

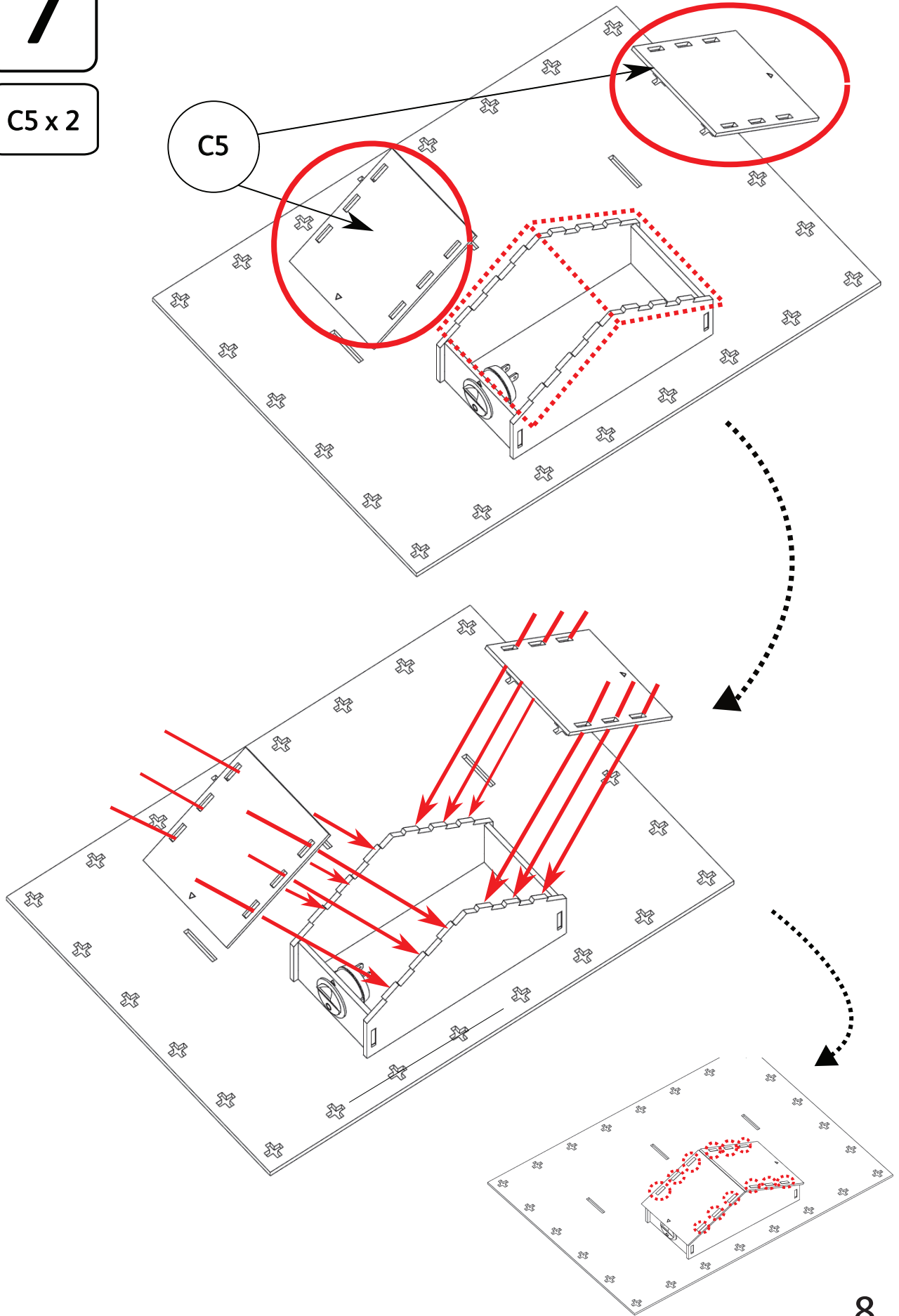

8

8

C6 x 3

C6

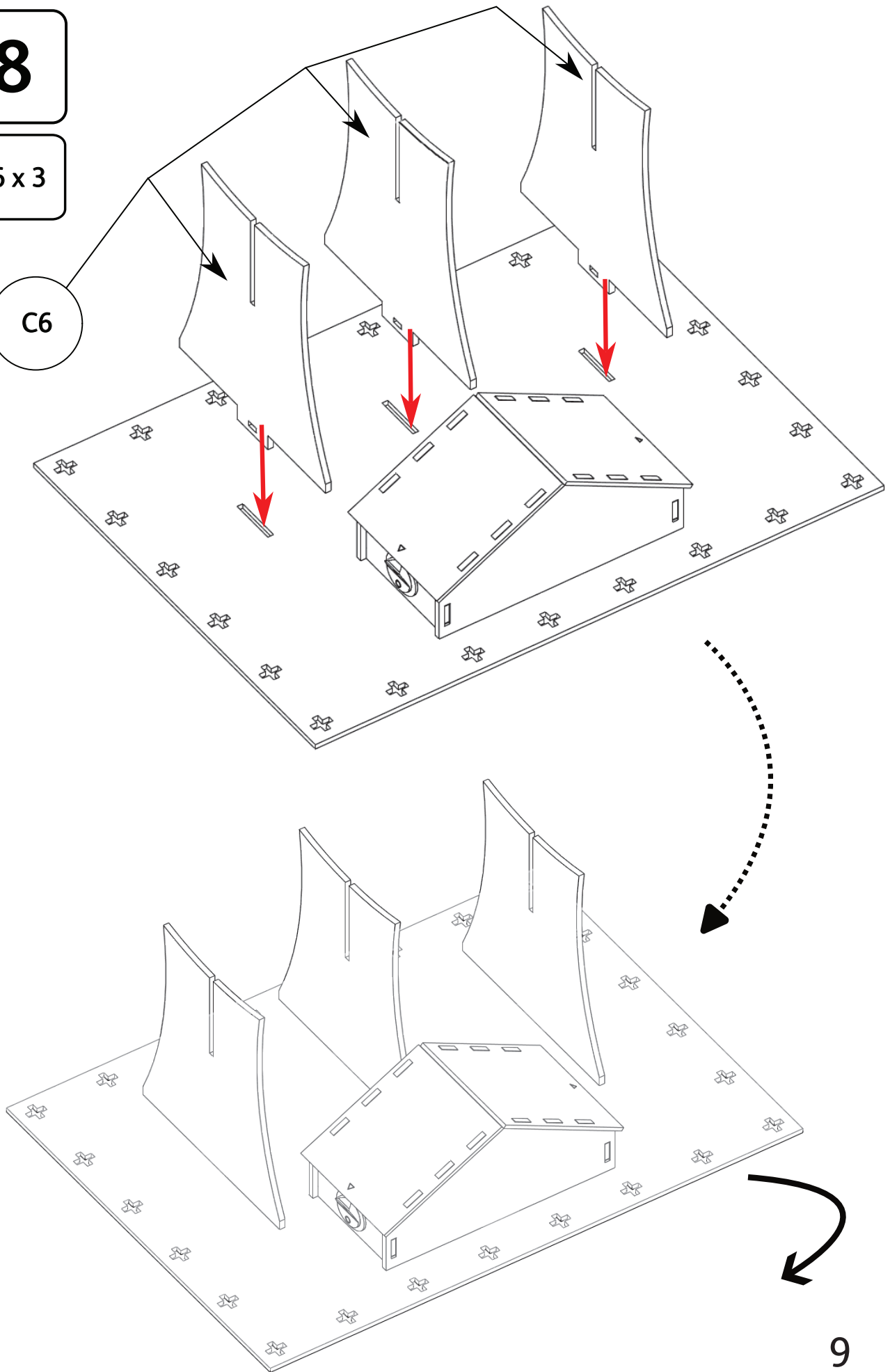

9

9

A x 3

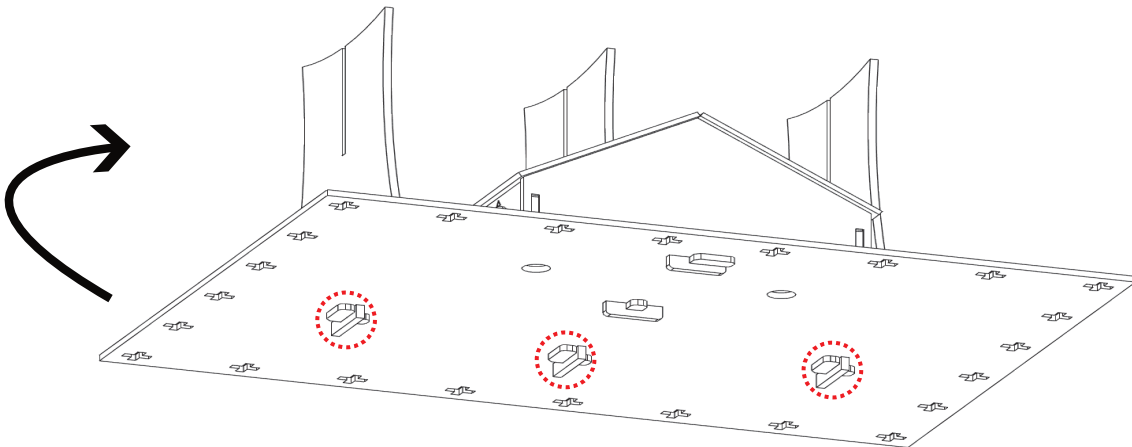
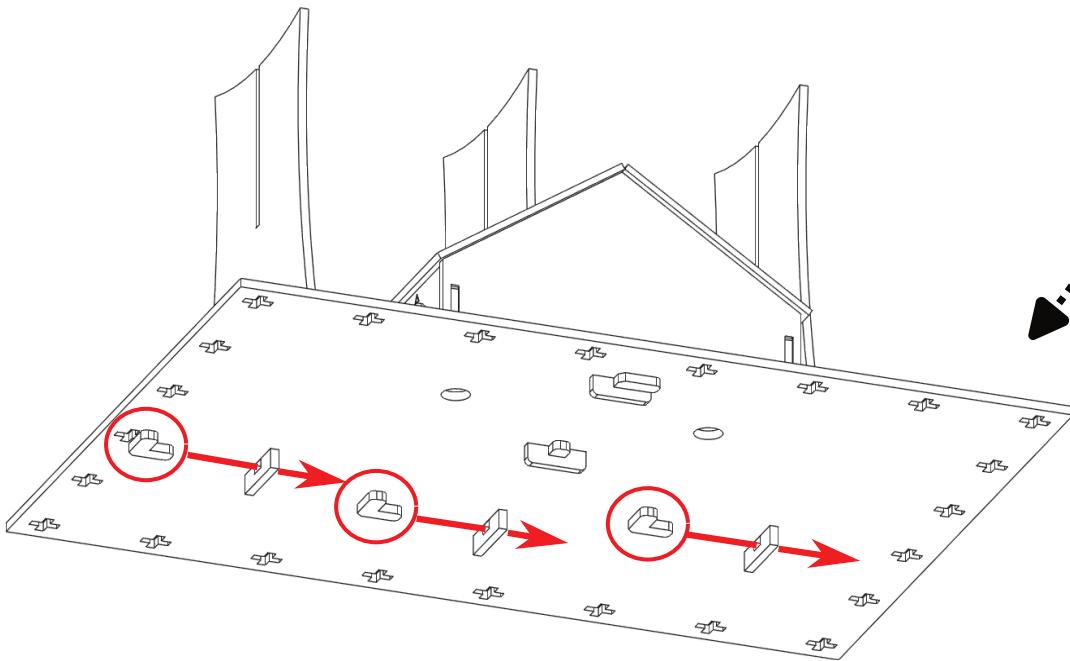
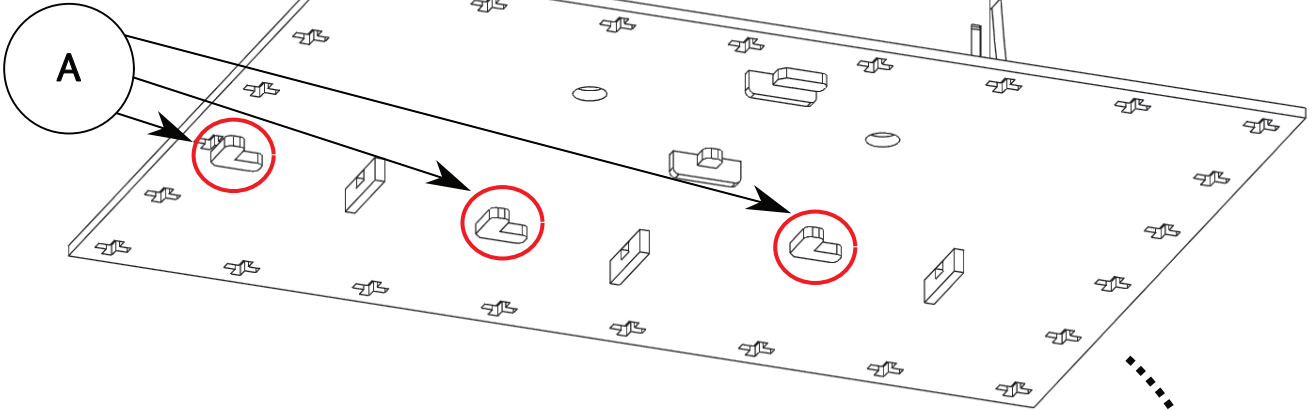

10

10

C7 x 3

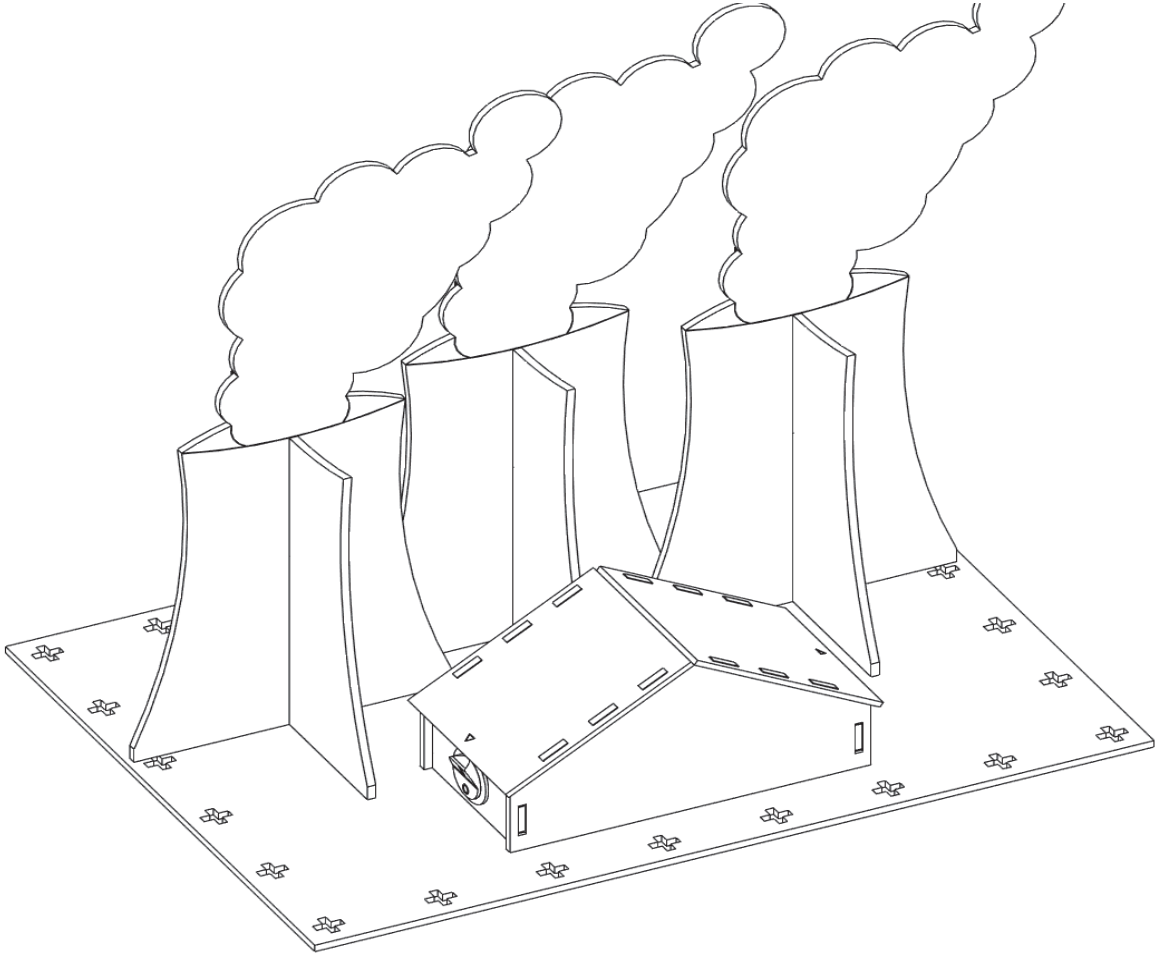
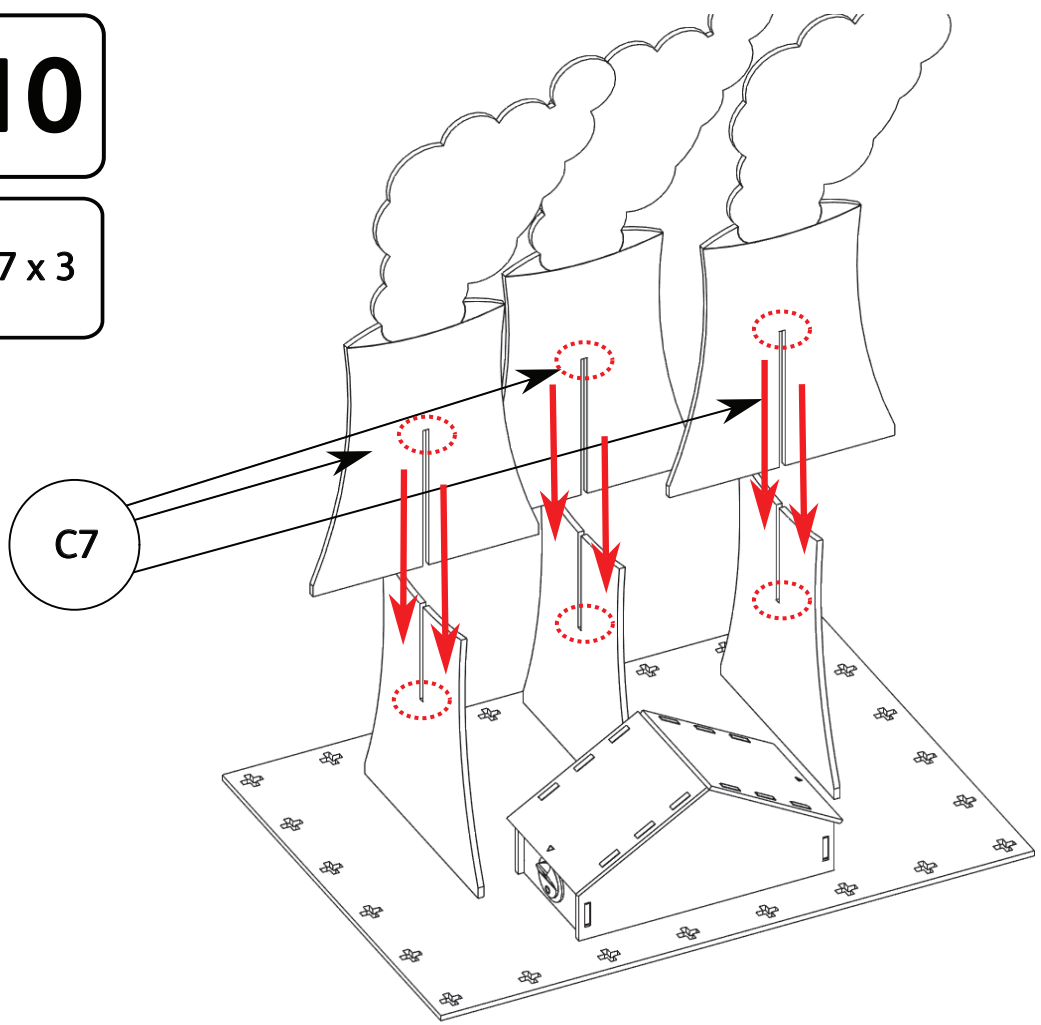



Powered by
Rewise

Romania